

Mini Air Operated Diaphragm Pumps

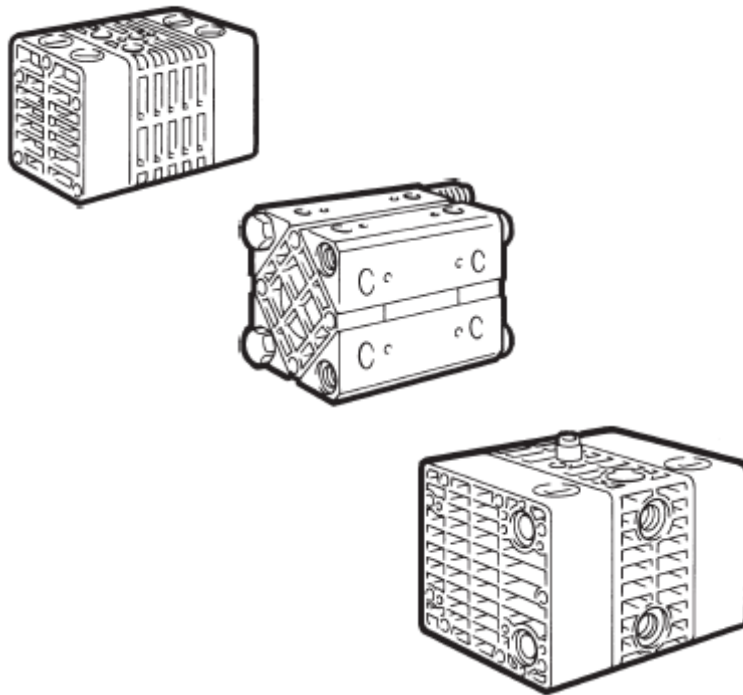

Installation, Operation and Maintenance

BTS
ENGINEERING

<https://prom-nasos.pro>

<https://bts.net.ua>

<https://prom-nasos.com.ua>

+38 095 656-37-57

+38 067 360-71-01

+38 063 362-12-31

info@prom-nasos.pro

INDEX

FOREWORD.....	3
INTRODUCTION.....	3
PUMP IDENTIFICATION.....	4
PUMP DESCRIPTION.....	5
TECHNICAL FEATURES.....	7
WARRANTY.....	8
SAFETY RULES.....	9
TRANSPORT AND POSITIONING.....	11
CONNECTED THE PRODUCT CIRCUIT.....	13
PNEUMATIC CONNECTION.....	14
COMMISSIONING.....	16
PRODUCT CIRCUIT MAINTENANCE.....	18
A-CLEANING AND REPLACING BALL SEATS.....	19
B-CLEANING AND REPLACING DIAPHRAGMS.....	20
AIR CIRCUIT MAINTENANCE.....	22
A-REPLACING PNEUMATIC EXCHANGER.....	23
TROUBLESHOOTING.....	25
DECOMMISSIONING.....	26
DEMOLITION AND DISPOSAL.....	27
SPARE PARTS.....	27

FOREWORD

Mini air operated diaphragms pumps have been manufactured to the 98/37/CE, 94/9/CEE & 99/92/EC directives.

The relevant area criteria are indicated in the EN-60079-10 and EN 1127-1 harmonized European standards.

Therefore, if used according to the instructions contained in this manual, the Mini pumps will not represent any risk to the operator. This manual must be preserved in good condition and or accompany the machine as reference for maintenance purposes. The manufacturer rejects any liability for any alteration, modification, incorrect application or operation not complying with the content of this manual and that may cause damage to the health and safety of persons, animals or objects stationing near the pumps.

The Manufacturer trusts you will be able to make full use of the performances offered by mini pumps. All the technical values refer to the standard version of Mini pumps (please see "TECHNICAL FEATURES"). However, our continuous search for innovation and improvements in the technological quality means that some of the features may change without notice.

All drawings and any other representation in the documents supplied with the pump are property of the Manufacturer who reserves all rights and FORBIDS distribution to third parties without his authorization in writing.

THEREFORE REPRODUCTION. EVEN PARTIAL. OF THIS MANUAL, TEXT OR DRAWINGS ARE STRICTLY FORBIDDEN.

INTRODUCTION

This manual is an integral part of the pump, and represents a SAFETY DEVICE, it contains important information that will assist the purchaser and his personnel in installing, using and servicing the pumps in good condition and safety during service life. At the head of every chapter an information field with symbols indicates the personnel who are authorized to perform the operation described in that page along with individual protective devices that must be worn and/or the energetic state of the pump. Any residual risk that may occur during these operations is highlighted by special symbols embedded in the text. Special symbols are also used to highlight and differentiate any particular information or suggestion concerning safety and correct use of the pumps.

PLEASE CONTACT THE MANUFACTURER'S CUSTOMER ASSISTANCE DEPARTMENT FOR ANY FURTHER INFORMATION REGARDING THE CONTENTS OF THIS MANUAL



WARNING: This sign warns the personnel involved that failure to perform the operation described in compliance with the procedures and prescriptions related to safety regulations entails residual risks that may cause damage to health or injuries.



CAUTION: This sign informs involved personnel that failure to perform the described operation in compliance with safety regulations may cause damage to the machine and/or its components hence risks for the operator and/or the environment.



REMARK: This sign provides information regarding the current operation and whose content is very important.





COMPULSORY AND INDIVIDUAL PROTECTION SIGNS:



These signs indicate that proper individual protection must also be used against energetic events because of the dangers that may arise during the operation.

 **OPERATOR:** This function entails full knowledge and understanding of the information contained in the user manual issued by the Manufacturer as well as specific skills related to the sector of use.

 **INSTALLER AND MECHANICAL SERVICEMAN:** This function entails full knowledge and understanding of the information contained in the user manual issued by the Manufacturer as well as specific skills related to the sector of use.

 **EXTRAORDINARY PROCEDURES:** Identifies operations to be performed by the technicians of the after-sales service only at the manufacturer's premises

PUMP IDENTIFICATION

Each pump has an identification plate carrying its specification details and materials. Always refer to this data when contacting the manufacturer, dealer or customer service centers.

Identification code * on (he plate against the "TYPE" heading specifies the composition and the materials used to build the pump. This data will help ascertain whether the pump is suitable for the product to be pumped.

 **WARNING: removing or altering this identification plate and or the data it contains is forbidden.**

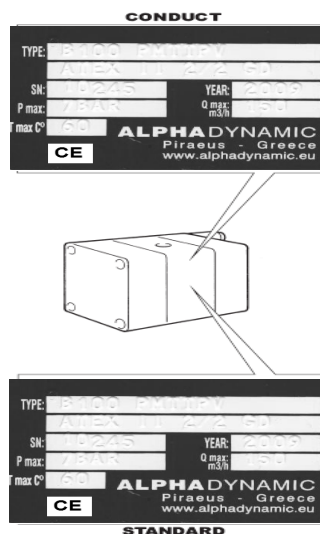

MARKINGS AND GENERAL INFORMATION

in compliance with the 94/9/CEE standards, the pumps carry the following identification marks:

 II 2/2 GD c IIB T135C &  II 3/3 GD c IIB T135C
 safety symbol to Din 40012 attachment A.

II 2/2: Where an explosive atmosphere in the form of a cloud of combustible dust in air is likely to occur in normal operation occasionally (EN 1127-1 pas 6.3)

II 3/3 : Surface installations used in areas where an explosive atmosphere in the form of a cloud of combustible dust in air is not likely to occur in normal operation and if it does occur , will persist for a short period only

c: protection by constructional safety {EN 13463-5).

IIB: Excluding the following products hydrogen, acetylene, carbon disulphide.

T135C: Class of admitted temperatures. The processed fluid temperature value must fall within such class range and the user must comply with the instructions contained in the manual and with the current laws. Furthermore, the user must take into account the ignition point of the gases, vapors and mists in addition to clouds of combustible powder in the air existing in the area of use.

The technical sheet is deposited with TUV NORU CERT Hanover.

PUMP DESCRIPTION

Proposed use

The air-driven Mini pumps have been designed and constructed to pump liquids with an apparent viscosity of between 1 and 50.000 cps at 20C that are chemically compatible with the pump's components. Fluid service temperatures must range from +3 C to a maximum of 60/95 C according to the material of the components. Its use is defined by the type of material used to build the pump, the temperature class and the type of fluid. The maximum temperature allowed for process fluid or powder depends on and/or is declassified by the material of the pump; if exceeded, respect of the maximum temperature shown on the marking cannot be guaranteed.

TEMPERATURE CLASSES FOR PUMPS TO BE INSTALLED IN AN EXPLOSIVE ENVIRONMENT (ZONE 1) T135 C(T4) is the temperature class corresponding to the protection against the risk of explosion of the pumps designed for use in explosive atmo-spheres; the data and operating conditions are shown here below:

DEFINITION OF THE CALCULATION DATA:

- *T4 = ATEX temperature class 135 C
- *Ta = maximum ambient temperature 40 °C;
- *Tl = maximum temperature for dry use of the pump in the work-place (50 C);
- *s = safety factor (5 C);
- *Tx = calculation factor (Tl +s) only for ZONE 1 ; .
- *Tf = maximum allowed fluid processing temperature

The formula used to determine the maximum allowed fluid processing temperature for CONDUCT version pumps II 2/2 GD c IIB T135 C) is shown here below.

ONLY FOR PUMPS TO BE INSTALLED IN ZONE 1

ATEX TEMPERATURE CLASS	CALCULATION FACTOR (only for ZONE 1)	MAXIMUM FLUID PROCESSING TEMPERATURE
T4	Tx =	Tf
135°C	55°C	80°C



WARNING: In consideration of the admitted ambient temperature variation range in zone 1, fluid service temperature values higher than those indicated above will not permit compliance to the corresponding T4 (135 C) temperature classes besides causing damages to the pump. Where the user presumes that the temperature limits set forth in this manual may be exceeded, a protective device must be installed on the system to prevent the maximum allowed fluid processing temperature from being reached. The equipment's maximum temperature has been determined with no powder deposits on the external and internal surfaces.

FUNCTIONING PRINCIPLES

The air introduced behind the diaphragm pushes the product to the delivery side. At the same time, it uses the shaft to draw the opposite diaphragm, which causes suction at the intake side. When complete, the cycle reverses.

improper use

 **WARNING: use of Mini pump for any other use other than that previously described in the chapter entitled "TECHNICAL CHARACTERISTICS" is to be considered improper use of the pump and is therefore forbidden by ALPHADYNAMIC CO.**

In particular, it is **FORBIDDEN** to use MINI pumps for :

- production of vacuum;
- operation as an on-off valve, as a non-return valve or as a metering valve
- operation with liquid that is chemically incompatible, with the materials of construction;
- operation with suspended products whose specific weight is higher than the liquid's (for example with water and sand),
- with air pressures, temperatures or product characteristics that do not comply with the pump's technical data;
- edible liquids.

 **WARNING: since an endless variety of products and chemical compositions exist, the user is presumed to have the best knowledge of their reaction and compatibility with the pump's construction materials. Therefore, before using the pump, all necessary checks and tests must be performed with great care to avoid even the slightest risk, an event that the manufacturer cannot foresee and for which he cannot be held responsible.**

 **WARNING: the user must consider the ratio between the pump's maximum surface temperature indicated on the marking and the minimum ignition temperature of the layers and clouds of powder as shown in the EN1227-1.**

 **WARNING. Use of the pump that does not comply with the instructions indicated in the use and maintenance manual will cancel the safety and explosion protection requirements. The risks associated with use of the pumps under the exact conditions set forth in the use and maintenance manual have been analysed, whilst the analysis of the risks associated with the interface with other system components must be carried out by the installer.**

The user is responsible for classifying the area of use whilst identification of the equipment category is the responsibility of the manufacturer

TECHNICAL FEATURES

The data related to performance refer to standard versions. 'MAX delivery" and 'Suction capacity" values refer to the pumping of water at 18C with a submersed manifold (please see fig. 1).

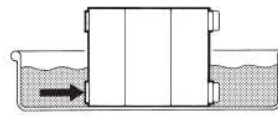
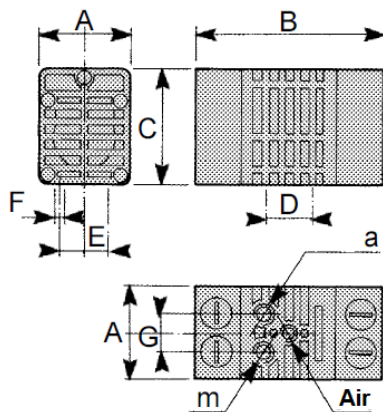

fig.1

⚠ WARNING: the declared capacity of dry negative suction refers to the intake of fluids with a viscosity and specific weight equal to 1; the performance and duration of the pump's membrane depend on the following factors:
 -the fluid's viscosity and specific weight;
 -the length and diameter of the suction pipe.

NEGATIVE SUCTION: with fluids max up to 5,000 cps at 18° C
BELOW HEAD SUCTION: with fluids up to 50,000 cps at 18° C

Mini005



Mini017

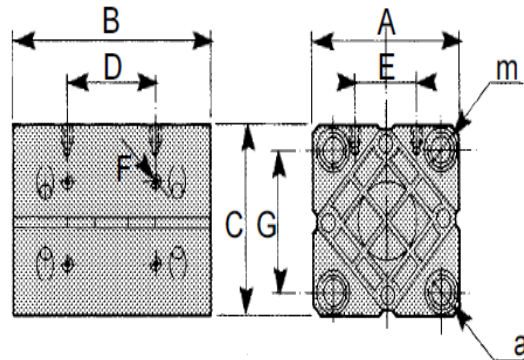

Pump	m-a	A	B	C	D	E	F	G
Mini 005	1/4"	60	121	75	30	37	03	25
Mini 017 PP	3/8	105	141	105	61	49	M6	78,5
Mini 017 ECTFE	3/8	105	141	105	61	49	M6	78,5

TECHNICAL DATA		UNIT	mini005	mini017
Intake / delivery fittings		inches	G 1/4"	G 3/8"
Air fittings		Inches	G 1/8"	G 3/8"
Suction capacity whilst dry (diaphragm PTFE)		m	3	3
Air pressure (MIN-MAX)		Bars	2-7	2-7
Fluid max temp. pressure	PP+CF zone 1 PVDF / ECTFE + CF ZONE 1	C	60	60 80
	PP (zone 2) PVDF/ECTFE ZONE 2	C	60 --	60
Max capacity water at 18C with submersed intake manifold		L//MIN	5	17
Net weight	PP	Kg	0,5	1,0
	PVDF/ECTFE	Kg	-	1,5
Noise (a bar with rubber balls)		dB(A)	65	70

WARRANTY

The high quality of Mini pumps is often confirmed to us by the end users. However, should any defect appear, please contact the Manufacturer's After-Sales Service, your dealer or the nearest Customer Service Centre where you will receive assistance as quickly as possible. In any case, please provide:

- A-Your complete address**
- S-Pump identification**
- C- Explosion risk protection class**
- D- Anomaly description**

All **Mini** pumps are covered by the following warranty:

1. Twelve months for any faulty mechanical parts. The warranty period starts from the date of supply.
2. Any fault or anomaly must be reported to the the Manufacturer within eight days.
3. Warranty repair will be carried out exclusively at the Manufacturer's premises. Transportation charges will be at the client's expense.
4. Warranty shall not be extended in case of repair or replacement.
5. Faulty parts must be forwarded to the Manufacturer who reserves the right to test them in this own factory to identify the fault or any external reason that may have caused it. Should the parts be found not faulty, the Manufacturer reserves the right to invoice the total cost of the parts that had been replaced under this warranty.

Costs and transportation risks of faulty, repaired or replaced parts including custom charges will be borne entirely by the client.

Repair or replacement of faulty parts cover any obligation under this warranty.

The warranty DOES NOT cover any indirect damage and in particular any normal consumable material such as diaphragms, ball seats, and others.

The warranty does not cover parts damaged as a consequence of incorrect installation, carelessness, neglect, incorrect maintenance, or damages due to transportation or to any other reason or event that is not directly linked to functional or manufacturing defects.

The warranty excludes all cases of improper use of the pump or incorrect applications or non-observance of the information contained in this manual.
Any controversy falls within the jurisdiction of the Court of Athens.

SAFETY RULES

Dangerous or hazardous practices or practice not complying with the safety rules and with the recommendations contained herein, may cause serious injuries, material damage and even explosions and /or death for which the manufacturer cannot be held responsible.

 **WARNING:** these instructions are essential for the pumps' compliance to the requirements of the 94/9/CE directive and must therefore be available, known, understood and applied.

 **WARNING:** the personnel in charge of installing, inspecting and servicing the pumps must have suitable technical knowledge and training in matters concerning potentially explosive atmospheres and the related risks.

 **WARNING:** use of the pumps in a manner that does not comply with the instructions indicated in the use and maintenance manual will cancel all the requirements for safety and protection against of explosions.

 **WARNING:** the maximum allowed temperature for process fluids or powder (zone 1) is equal 60/80 C depending on the construction materials: if exceeded, respect of the maximum temperature marked on the machine cannot be guaranteed.

 **WARNING:** before intervening on the pump and/or servicing or repairing it, please- note that you must:

- A - Discharge any product that was being pumped
- B - Wash it internally using a suitable non-flammable fluid, then drain.
- C - Cut-off the air supply using the relevant valve and make sure that no residual pressure remains inside it.
- D - Close all on-off vavfes (defivery and intake sides) relative to the product;
- E - Disconnect the network air supply;
- F- Wear suitable individual protection before any maintenance or repair {goggles / face protection, gloves, closed shoes, aprons and others}.

 **WARNING:** before using the pump, make sure that the fluid to be pumped is compatible with the explosion protection class and with construction materials of the pump.

DANGER OF CORROSION, PRODUCT SPILLS AND/ OR EXPLOSIONS CAUSED BY CHEMICAL REACTIONS.

For installation and use in a potentially explosive environment, comply with these general precautions:

- ascertain that the pump is full and if possible, that the level is above it by 0.5 m;
 - ascertain that the fluid treated does not contain or cannot contain large solids or solids of a dangerous shape.
 - ensure the intake or delivery ports are not obstructed nor limited to avoid cavitation or pneumatic motor strain;
 - also ascertain that the connection piping is strong enough and cannot be deformed by the pump weight or by the intake. Also check hat the pump is not burdened by the weight of the piping.
 - If the pump is to stay in disuse for a long period of time, clean it carefully by running a non-flammable liquid detergent through it that is compatible with the pump's construction materials;
 - if the pump was turned off for a long period of time, circulate clean water it in for some minutes to avoid incrustations.
-
- before starting, after long periods of disuse, clean the Internal and external surfaces with a damp cloth;
 - check the grounding;

- always protect the pump against possible collisions caused by moving objects or by various blunt materials that may damage it or react with its materials;
- protect the pump's surrounding ambient from splashes caused by accidental pump failure;
- if the diaphragms are completely torn, the fluid may enter the air circuit, damaging it, and be discharged from the exhaust port. It is therefore necessary for the exhaust port to be conveyed by pipes to a safe area.

 **WARNING:** the air supply pressure must never be over 7 bar or below 2 bar.

 **WARNING:** when using the pump with aggressive or toxic liquids or with liquids that may represent a health hazard you must install suitable protection on the pump to contain, collect and signal any spills: **DANGER OF POLLUTION, CONTAMINATION, INJURIES AND/OR DEATH.**

 **WARNING:** the pump must not be used with fluids that are not compatible with its construction materials or in a place containing incompatible fluids.

 **WARNING:** installing the pumps without on-off valves on the intake and delivery sides to intercept the product in case of spillage is forbidden: danger of uncontrolled product spillage.

 **WARNING:** installing the pumps without on-off, three way or check valves on the air supply piping to prevent the pumped liquid from entering the pneumatic circuit if the diaphragms are broken is forbidden: danger of fluid entering the compressed air circuit and being discharged into the environment.

 **WARNING:** Should the user think that the temperature limits set forth in this manual may be exceeded during service, a protective device must be installed on the system to prevent the maximum allowed process temperature from being reached. If exceeded, respect of the maximum temperature marked cannot be guaranteed.

 **WARNING:** The pumps must always be grounded irrespective of any organ to which they are connected. Lack of grounding or incorrect grounding will cancel the requirements for safety and protection against the risk of explosion.

 **WARNING:** The Mini005 pumps are equipped with valves using springs, therefore be careful when pumping corrosive or dirty products.

 **WARNING:** the use of pumps made with non-conductive material, which become charged with static, and without suitable grounding for flammable liquids is forbidden: **RISK OF EXPLOSIONS DUE TO STATIC CHARGE**

 **WARNING :** Aggressive, toxic or dangerous liquids may cause serious injuries or damage to health, therefore it is forbidden to return a pump containing such products to the manufacturer or to a service center. You must empty the internal circuits from the product first and wash and treat it.

 **WARNING:** The components of the pneumatic exchanger, including the shaft are made from materials that are not specifically resistant to chemical products, if the diaphragm should break, replace these elements completely if they have come into contact with the product.

 **WARNING:** The air-driven motor of the Mini pumps is self-lubricating and will not require any greasing. Therefore avoid using lubricated and non-dried air.

 **WARNING:** ascertain that during service no anomalous noise appears. In that case, stop the pump immediately.

⚠ WARNING: ascertain that the fluid at the delivery side does not contain gas. Otherwise stop the pump immediately

⚠ WARNING: the diaphragms (in contact with the product or the external ones) are highly subject to wear. Their duration is strongly affected by the conditions of use and by chemical and physical stress. Fields tests carried out on thousands of pumps with a head value from 0C to 18 C have shown that normal service life exceeds one hundred million cycles. However, in places at risk of explosion, the diaphragm must be disassembled and checked every 5 million cycles and replaced every 20 million cycles.

⚠ WARNING: Periodic controls must be made to ensure that there is no powder and/or deposits on the external and internal surfaces of the pump and, if necessary, they must be cleaned with a damp cloth.

⚠ WARNING: removal of the silencer and the air supply fitting must be done when free from powder. Before restarting the pump, ensure that no powder has entered the pneumatic distributor.

To replace worn parts, use only original spare parts.

Failure to comply with the above may give rise to risks for the operator, the technicians, the persons, the pump and/or the environment that cannot be ascribed to the manufacturer.

TRANSPORT AND POSITIONING

Upon receipt, please check that the packing and the pump are intact and have not been damaged. Then:

1. Read the User and Maintenance Manual and proceed as explained
2. Make sure that all of the pump's screws are well tightened

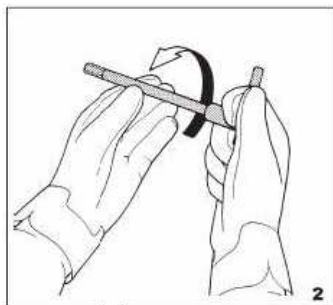

3. if the pump has been forwarded with drain silencer disassembled, mount the same.



3

WARNING: Position and secure the pump horizontally using hangers fixed to the ceiling or feet resting on the ground. The product delivery manifold must always be positioned on the upper part according to the signs:
"OUT" = DELIVERY (up)
"IN" = INTAKE (down) or according to the pump model, check that the arrows shown onto the casing are always pointing upwards.

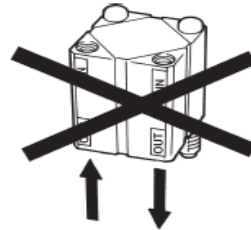

6. Position the pump correctly on site chosen for installation, as close as possible to the point of collection and secure onto the feet using the bolts supplied. Arrange for enough room to carry out maintenance.

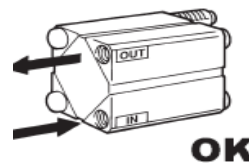

WARNING: diaphragm pumps with negative suction are affected by the following factors:
 -viscosity and specific weight of the fluid;
 -suction diameter and length.

Position the pump as close as possible to the point of collection (within 2.5 m.) and in any case never more than 5 m. The diameter of the intake pipe must never be smaller than the connection of the pump, but must be increased as the distance increases. Fluid to be pumped with negative suction must never exceed a viscosity of 5.000 cps at 20° C and a specific weight of 1.4 Kg/l. These elements can cause derating and reduce the duration of the diaphragm: **DANGER OF PREMATURE BREAKAGE.**

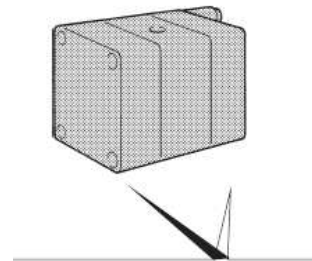

7. If the pump is made from conductive materials and is suitable for flammable products, each pump casing must be equipped with a suitable earthing cable: **DANGER OF EXPLOSION AND / OR FIRE.**

WARNING The pumps must always be grounded irrespective of any organ to which it is connected. Lack of grounding or incorrect grounding will cancel the requirements for safety and protection against the risk of explosion.

This completes positioning .

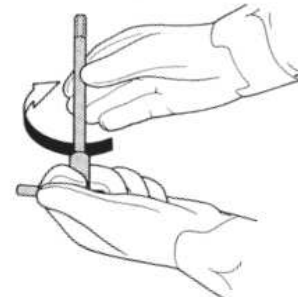

6

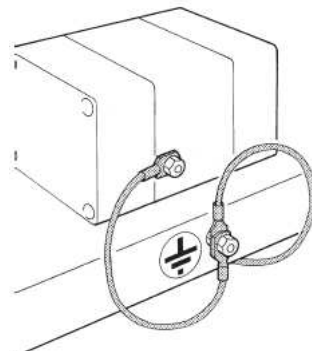

7

CONNECTING THE PRODUCT CIRCUIT

After positioning the pump you can now connect it to the product circuit as follows:

WARNING: only fittings with cylindrical gas threads in materials compatible with both the fluid to be pumped and the pump's construction materials must be used.

For example:

Pump made from PP - PP fitting

Stainless steel pump = stainless steel fitting.

1. On the delivery and discharge manifold install a manual valve of the same diameter as the pump inlet (never smaller) to intercept the fluid correctly in case of spills and / or when servicing the pump.

1. Install the sleeves to secure the flexible hoses on both valves.

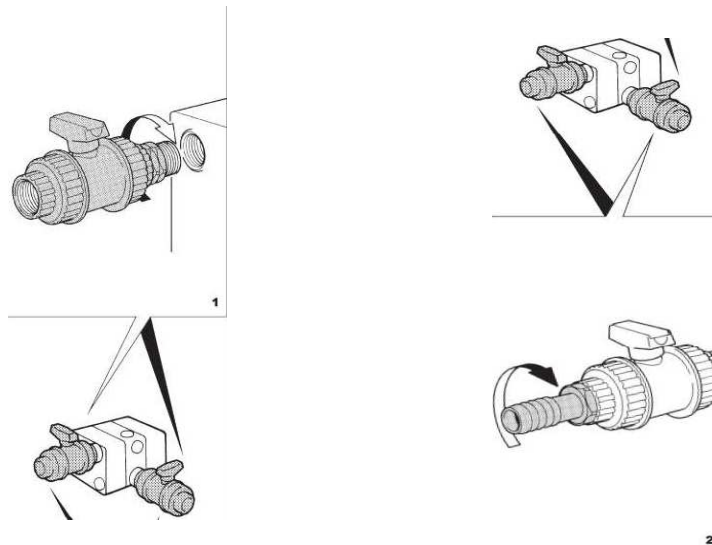

⚠ WARNING: the pump must be connected with FLEXIBLE HOSES REINFORCED WITH A RIGID SPIRAL of a diameter never smaller than the pump's connection. The filters or other equipment installed at the intake side must be suitably dimensioned in order to avoid pressure drops. For negative installations and/or viscous fluids, use hoses with an OVERSIZE DIAMETER, especially on the intake side. Connections using rigid pipes may cause strong vibrations and break the manifolds.

3. Connect the product intake and delivery hoses to their respective fittings whilst taking into consideration the signs on the pump:

"IN" = INTAKE (down) and

"OUT" = DELIVERY (up)

or according to that indicated by the arrows.

4. Secure the hoses using the relevant clamps.

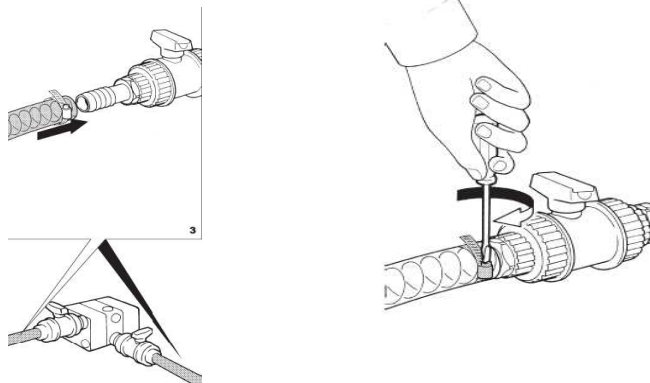

WARNING : Provide appropriate support for the piping. **THE PIPING MUST BE STRONG ENOUGH TO AVOID DEFORMATION DURING THE SUCTION PHASE AND MUST NEVER WEIGH DOWN ON THE PUMP IN ANY WAY OR VICE VERSA .**

5 . If used for drum suction (not below head), the submersed end of the intake hose must be provided with a diagonally cut fixing to prevent it from adhering to the drum bottom.

WARNING: Ascertain that the fluid treated does not contain or cannot contain large solids or solids of a dangerous shape and that the intake or delivery ports are not obstructed nor limited to avoid either cavitation or pneumatic motor strain.

Connection off the product circuit finishes here.

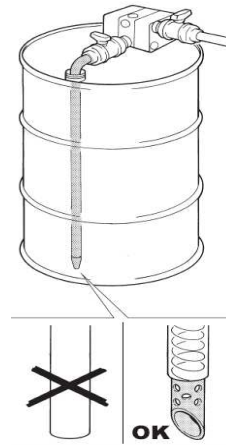

PNEUMATIC CONNECTION

To connect the pump to the pneumatic circuit, you must: **WARNING: pneumatic supply to the MINI pumps must be made using FILTERED. DRIED. NON LUBRICATED OIL FREE AIR** at a pressure of not less than 2 bars and not more than 7 bars.

WARNING : do not remove **RESET** for any reason and/or do not connect the air supply to the **RESET** channel

1. Install an on-off valve, a three-way valve and a check valve on the pneumatic circuit connection on board the pump according to the layout shown in figure 1.

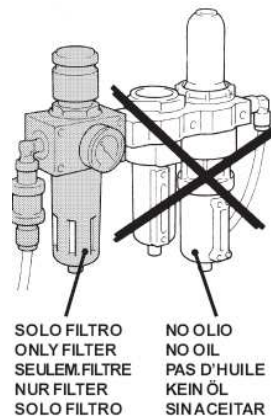
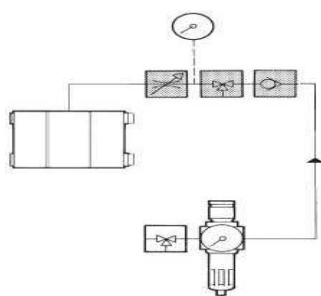

REMARK: to verify actual air pressure, you must install a pressure gauge immediately before the valve and test while pump is running.

2. Connect the supply hose from the net work to the pump circuit.

WARNING: To avoid in pressure drops, use hoses, accessories and control and regulation elements whose delivery and pressure characteristics arc suitable to the pump s own characteristics.

WARNING:Most snap-on fittings cause pressure drops.

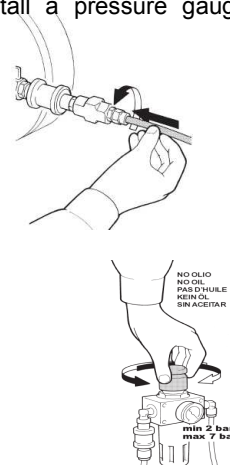

2. Adjust the network pressure of the compressed air to guarantee a pressure of NOT LESS THAN 2bars AND NOT MORE THAN 7 bars when the pump is running. For BOXER pumps equipped WITH RUBBER BALLS, DO NOT EXCEED 5 bars. Lower or higher pressure may cause functional problems or pump breakage, product spills and damages to persons or objects.

 **REMARK:** to feed more than one pump with the same air control device, please ask our engineers.

 **WARNING:** For installation in Zone 1, should the user think that the temperature limits set forth in this manual may be exceeded during service, a protective device must be installed on the system to prevent the global temperature {fluid + ambient} from reaching temperatures higher than 80°C in the case of class T4 metallic or ECTFE pumps or 60°C for T4 class PP {polypropylene} pumps.

6. Always protect the pump from possible accidental collisions with moving objects or various blunt materials that may damage it or react on contact with it.
7. Protect the site and the persons from accidental failures by installing a protection guard to hold and collect any product leakage: DANGER OF SERIOUS INJURIES AND DAMAGE TO HEALTH AND/OR OBJECTS.
8. . If the diaphragms are completely torn, the fluid may enter the air circuit, damaging it, and be discharged through the exhaust port, it is therefore necessary that the air exhaust be conveyed by pipes to a safe area.

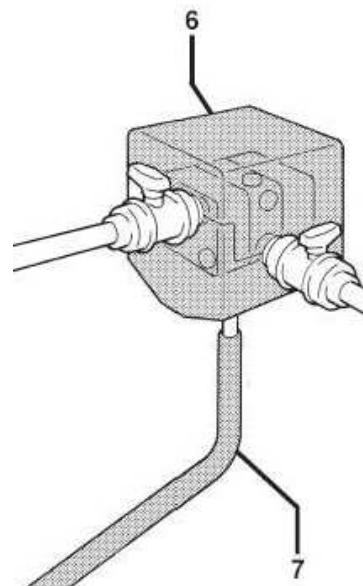

COMMISSIONING

The user must always use materials that are compatible with the pumped liquid according to the pump's design conditions.

⚠ WARNING: it is forbidden to use the pump with fluids that are not compatible with the pump's construction materials or in a place that contains incompatible fluids.

To commission the pump, proceed as follows :

1. Make sure that the product delivery and intake hoses are correctly connected - check the signs on the pump: "IN" = INTAKE (down) and "OUT" - DELIVERY (up)

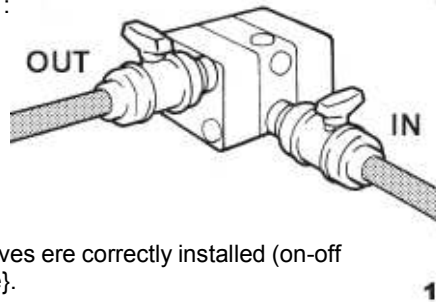

2. Check that the pump's pneumatic circuit valves are correctly installed (on-off ball valve, three-way valve and check valve).

3. Open the fluid intake and delivery Valves.

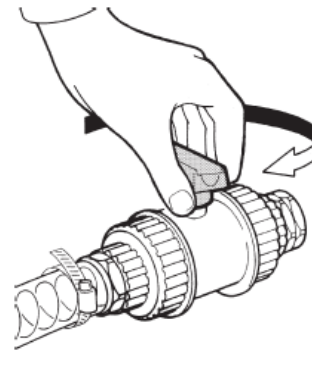
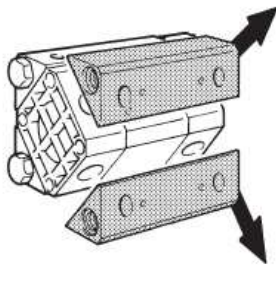

⚠ WARNING : never start the pump with the product valves (intake and delivery) closed: DANGER OF DIAPHRAGM BREAKAGE.

4. Open the on-off ball valve mounted on the pump connection.

5. Open the three-way valve.

6. Check and regulate the network air pressure when the pump is running: MIN 2 bar MAX 7 bar; max 5 bar for pumps with rubber balls

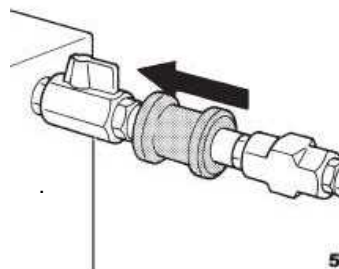
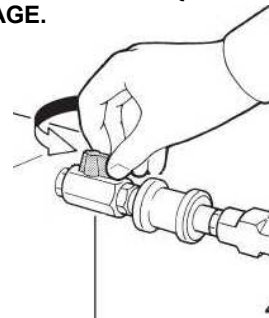

⚠ CAUTION: If the pressure is below 2 bars when the pump is running, the pump may STALL. At a pressure higher than the MAXIMUM threshold, yielding and leakages of the product under pressure may occur and/or the pump may break.

7. To regulate the speed of the pump according to the fluid viscosity, you can operate in two ways:

A- Regulate the network air pressure.

B- Choke the air volume (flow rate) by means of the on-off valve mounted on the pump

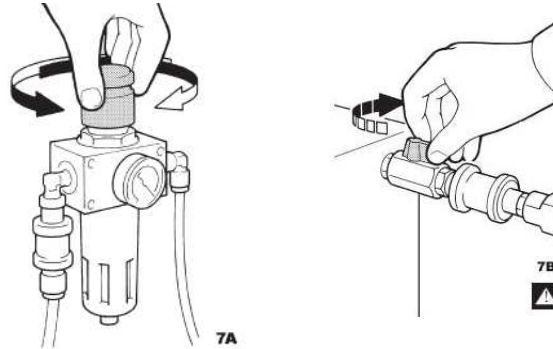

REMARK: unprimed pumps have a negative suction head capacity that varies according to the type of diaphragm and packing mounted. PLEASE CONTACT THE MANUFACTURERS CUSTOMER ASSISTANCE SERVICE FOR FURTHER DETAILS

WARNING: If the pump has negative suction, reduce the speed of the pump using the ball valve on the air supply.

WARNING: In pumps with split manifold. DO NOT USE TWO FLUIDS WITH DIFFERENT VISCOSITIES as STALL. PREMATURE DIAPHRAGM AND PNEUMATIC CIRCUIT WEAR may occur .

WARNING: never stop the pump when it is running and/or when the pneumatic circuit is under pressure by closing the intake and/or delivery valves on the fluid circuit: DANGER OF PUMP STALLING AND PREMATURE WEAR AND/OR BREAKAGE OF THE DIAPHRAGM.

8. Only the air supply must be used to stop the pump, by closing the three-way valve to discharge any residual pressure from the pump's pneumatic circuit.

Besides being damaging for the pump, cavitation is dangerous in a potentially explosive atmosphere:

You must ascertain that the pump has been sized correctly. In case of doubt, please contact ALPHADYNAMIC.

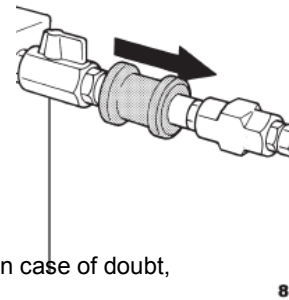

WARNING: ascertain that no anomalous noises occur during operation. If so, stop the pump immediately .

WARNING: ascertain that the fluid at the delivery side does not contain gas. Otherwise stop the pump immediately

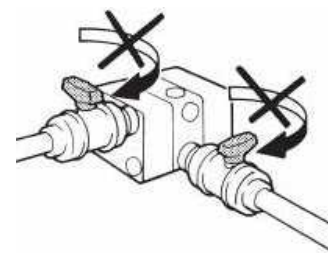

 **WARNING :** In the case of high viscosity fluids, do not use under-sized filters or piping, especially the intake side. Furthermore , you must decrease the pump speed by choking the volume of air whilst leaving pressure unchanged.

9. After two hours of operation, and after stopping the pump correctly, check that all of the bolts are tight.

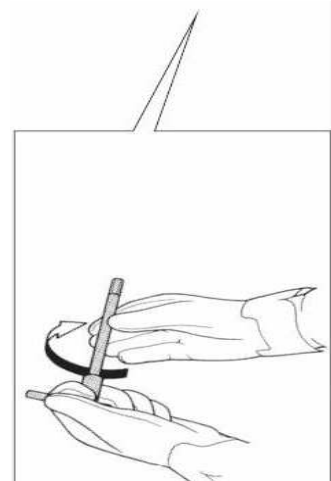

PRODUCT CIRCUIT MAINTENANCE

 **WARNING:** before intervening on the pump and/or performing any maintenance or repair, you must:

A - discharge the product being pumped and close the product on-off valves (both on the intake and delivery sides).

B- Circulate a suitable non-flammable washing fluid then drain it off and close the product shut-off valve.

C- Shut-off the air supply using the relevant three-way valve whilst making sure that no residual pressure subsists

D -Shut-off air supply upstream:

E - Wear suitable individual protective devices before intervening: goggles / masks, gloves, closed shoes, aprons, and others: **DANGER OF FLUID EJECTION UNDER PRESSURE.**

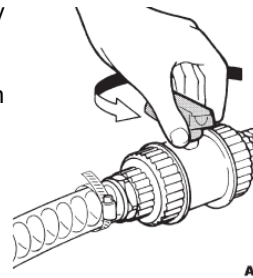

A

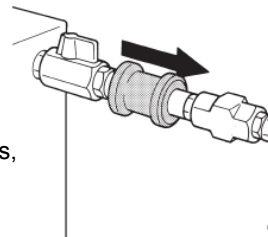

C

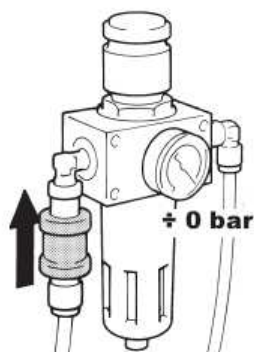

D



E



WARNING: remove deposits of powder from the external surfaces of the pump with a cloth soaked in suitable neutral detergents.

1. Disconnect fluid intake and delivery hoses from pump.

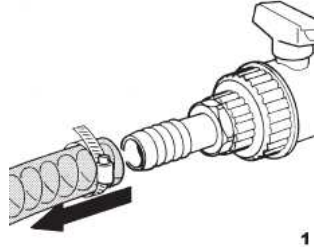

2. Disconnect the compressed air supply pipe from the pump.

3. Disassemble and remove the pump from its place of installation using suitable hoisting equipment.

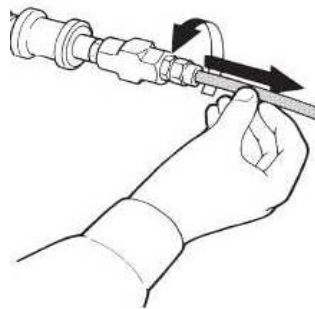
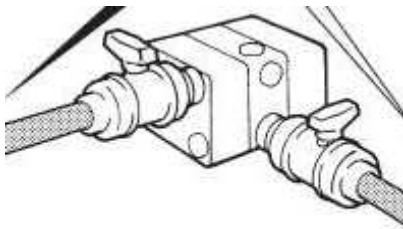

REMARK: refer to the relevant spare parts table for the order of assembly and reassembly when carrying out the above operations.

4. Periodically control and clean the internal surfaces with a damp cloth.

A CLEANING AND REPLACING THE BALLS AND BALL SEATS

To clean and/or replace the balls and ball seats, proceed as follows:



WARNING: before carrying out this operation all external surfaces of the pump must be cleaned using a damp cloth.

A1 In the case of the Mini017 pump disassemble intake and delivery manifolds by removing the fixing elements.

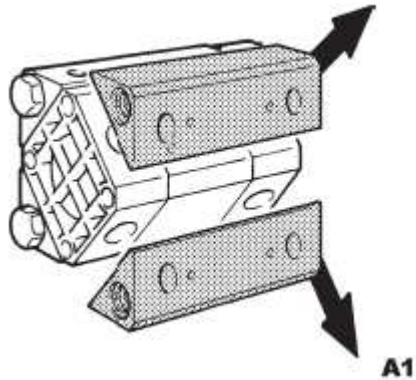

A2 Remove the seats and the balls and clean them with a damp cloth and/Or replace them with genuine spare parts of the same type (see spare parts tables).

A3 Check the condition of the gasket and, if necessary, replace with original spare parts of the same type.

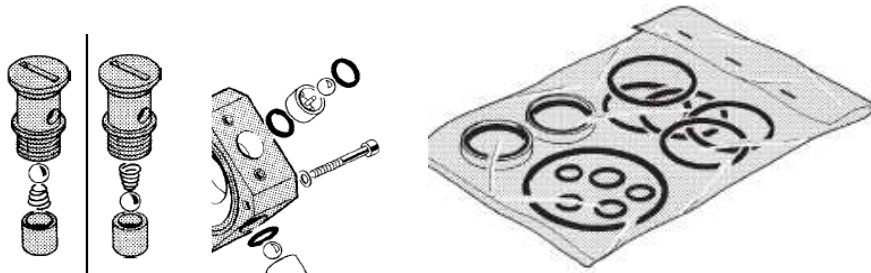

 **WARNING:** check that there are no deposits of any kind inside the pump, and if found remove them with a damp cloth.

A4 Reassemble by repeating the previous sequence in reverse order. Tighten the fixing bolts evenly.

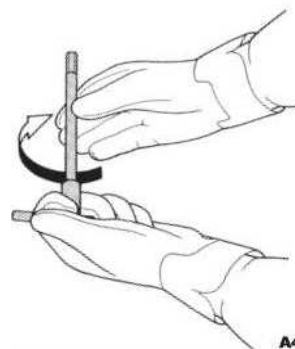

Cleaning and/or replacement of balls and ball seats finishes here You can now reposition the pump and reconnect it as described in the previous sections.

B CLEANING AND REPLACING THE DIAPHRAGMS

For good operation of the pump and to guarantee that all the safety and protection requirements against explosion risks have been taken, it is indispensable that the controls, cleaning and/or replacement of the diaphragms are carried out in accordance with the intervals shown in the table.

 **WARNING:** the diaphragms (in contact with the-product or the external ones) are highly subject to wear. Their duration is strongly affected by the conditions of use and by chemical and physical stress. Fields tests carried out on thousands of pumps installed with a head equal to 0C and with fluid at 18' C have shown that normal service like exceeds 100.000.000 (one hundred million) cycles. For safety reasons, in environments at risk of explosion, the diaphragms must be replaced every 20.000.000 (twenty million) cycles.

OBLIGATORY OPERATION	OPERATION TIME (n.r of cycles)		
	Every 500,000	Every 5 milion	After 20 milion
CONTROL AND INTERNAL CLEANING	*		
DIAPHRAGM CHECK	--	*	--
DIAPHRAGM REPLACEMENT	--	--	*

To replace product diaphragms proceed as follows:

 **WARNING:** The components of the pneumatic exchanger, including the shaft, are made from materials that are not specifically resistant to chemicals. Should the diaphragms break and the components come into contact with the fluid, replace them completely.

B1 Only in the case of Mini 017 pump disassemble the intake and delivery manifolds by removing the fixing elements.

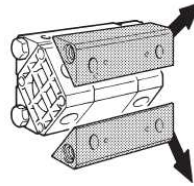

 **WARNING:** Periodic controls must be made to ensure that there are no deposits of powder on the internal surfaces and, if necessary, they must be cleaned with a damp cloth.

B2 Remove any deposits on the internal surfaces with a damp cloth.

B3 Disassemble the two pump casings by removing the fixing Screws.

B4 Remove the external diaphragm locking plate from both circuits.

B5 Check and/or replace the diaphragms on both sides of the pump with original spare parts of the same type.

 **WARNING:** ascertain that the inner part of the pump is free from all types of deposits and if they are present proceed with their removal.

B6 Reassemble the pump following the disassembly sequence described earlier in reverse order. Tighten the fixing bolts evenly.

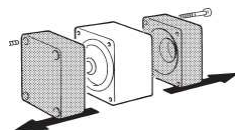

B3

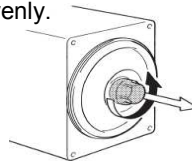

B4

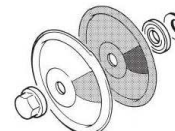

B5



WARNING: Should the pump be returned to the manufacturer or to a service center, you must first empty it out completely. If toxic, noxious or other types of dangerous products have been used, the pump must be suitably treated and washed before it is sent.

Replacing the diaphragms finishes here. You can now reposition the pump and reconnect it as described in the previous sections.

AIR CIRCUIT MAINTENANCE



WARNING: before intervening on the pump and/or before performing any maintenance or repair, you must:

A- Discharge the product that is being pumped and close the manual on-off valves (both on the intake and delivery sides).

B- Circulate a suitable, non-flammable washing fluid then drain it out and close the product shut-off valve.

C- Shut-off the air supply using the relevant three-way valve whilst making sure that no residual pressure subsists:

D- Shut- off air supply upstream:

E- Wear suitable individual protective devices before intervening: goggles/masks, gloves, closed shoes, aprons and others : DANGER OF EJECTION OF FLUID UNDER PRESSURE.

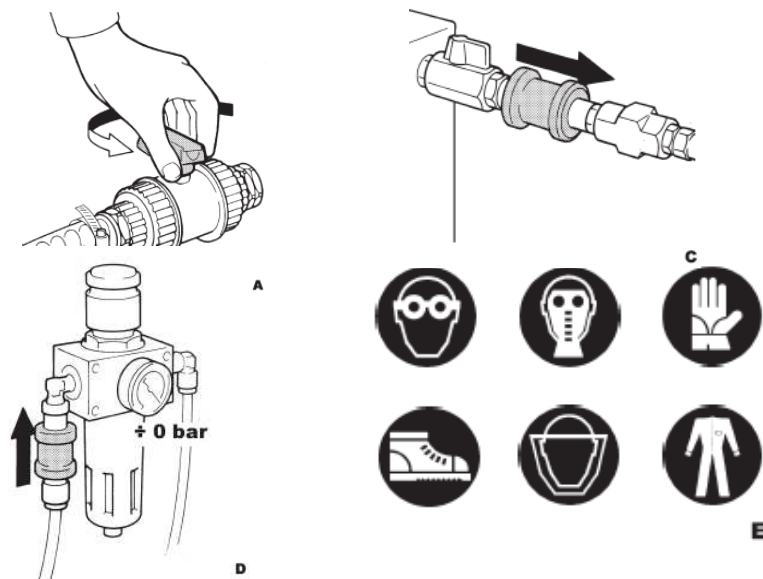

WARNING: Before removing the air supply pipe or fitting, clean the external surfaces of the pump. Before restarting the pump, ensure that no powder has entered the pneumatic distributor.

1. Disconnect the fluid in take and delivery hoses from the pump.
2. Disconnect the compressed air piping from the pump.
3. Disassemble and remove the pump from its place of installation using suitable hoisting: means.

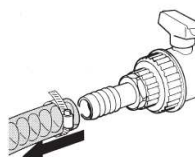

1

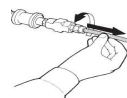
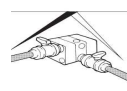

2

 **REMARK:** Refer to the relevant spare parts table for assembly and disassembly order when carrying out these operations.

A REPLACING PNEUMATIC EXCHANGER

To replace the pneumatic exchanger you must:

 **WARNING:** Should the pump be returned to the manufacturer or to the service center, you must empty it out completely. If toxic, noxious or other types of dangerous products have been used, the pump must be suitably treated and washed before it is sent.

A1 Disassemble the intake and delivery manifolds by removing their fixing elements.

A2 Disassemble the two pump casings by removing the relevant fixing screws.

A3 Remove the external diaphragm locking plate from both the circuits.

A4 Remove the diaphragms from both sides of the pump.

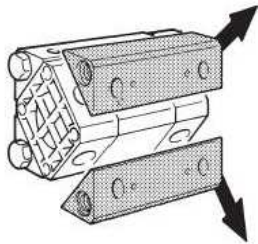

A1

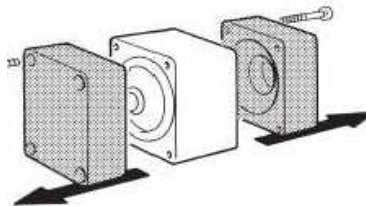

A2

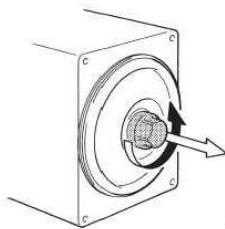

A3

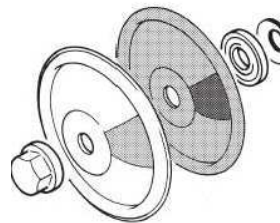

A4

A5 Disassemble the pneumatic exchanger by removing the relevant fixing elements.

A6 Replace the exchanger and the connection shaft with original spare parts having the same characteristics.

A7 Reassemble the pump according to the previously described sequence but in reverse order and tighten the fixing bolts evenly.

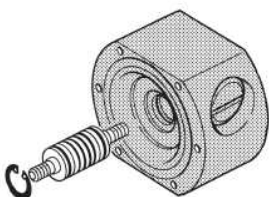

A5

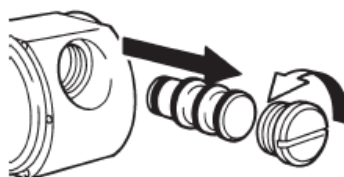

A6

A7 Reassemble the pump according to the previously described sequence but in reverse order and tighten the fixing bolts evenly.

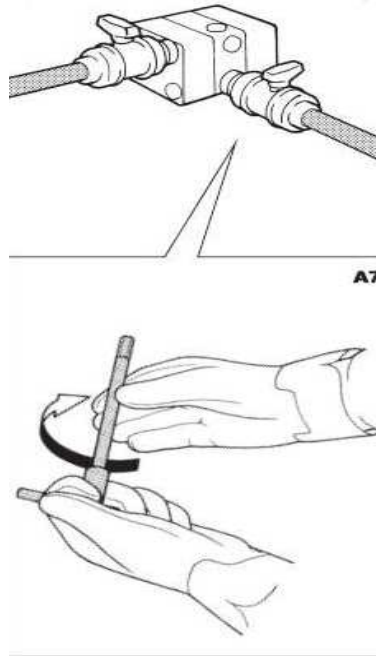

Replacement of the pneumatic exchanger finishes here. You can now reposition the pump and reconnect it as described in the previous sections

TROUBLESHOOTING

The following instructions are intended exclusively for authorised skilled maintenance engineers. In event of abnormal behaviour and in order to fix faults, please refer to the following troubleshooting instructions.

WARNING: For more serious problems, we strongly recommend that you contact the ALPHADYNAMIC SERVICE DEPARTMENT: our engineers will provide you assistance as quickly as possible.

1. The pump does not start

POSSIBLE SOURCE	ADVICE
1.1 No air in the circuit	1.1a Check circuit, valves and connections
1.2 Insufficient air pressure	1.2a Adjust pressure on the relevant reducer
1.3 insufficient air flow rate	1.3a Check that piping and accessories have suitable passage
1.4 Damaged control valve	1.4a Check and replace
1.5 Pump intake or delivery closed	1.5a Disconnect intake and delivery hoses and check
1.6 Pneumatic exchanger damaged	1.6a Replace exchanger, check whether (the air discharge is obstructed by ice. If so, clear it.
1.7 Broken diaphragm	1.7a Check if any air comes out from the product delivery pipe. If so, replace diaphragm.
1.8 Pump stalled.	1.8a Reset (page 20)

2. The pump runs but does not pump

POSSIBLE SOURCE	ADVICE
2.1 The balls do not close	2.1a Disassemble the manifolds and clean the ball seats or replace both balls and their seats
2.2. Intake too high	2.2a Reduce intake height
2.3 Fluid is too viscous	2.3a Install larger piping especially on the intake side and decrease the pump cycles
2.4 Intake side is obstructed	2.4a Check and clean

3. Pump cycles are slow

POSSIBLE SOURCE	ADVICE
3.1 Fluid is too viscous	3.1a No remedy
3.2 Delivery hose is obstructed	3.2a Check and clean
3.3 Intake is obstructed	3.3a Check and clean

4. Pump functions irregularly

POSSIBLE SOURCE	ADVICE
4.1 Internal pneumatic ex-changer is worn or faulty	4.1a replace pneumatic exchanger
4.2 Shaft is worn	4.2a Replace pneumatic exchanger
4.3 Ice on discharge gate	4.3a Dehumidify and filter air
4.4 Lack of air flow	4.4a Check all air control devices and in particular snap On couplings
4.5 Internal exchanger dirty	4.5a Replace

5. The pump stalls

POSSIBLE SOURCE	ADVICE
5.1 Intake obstructs during operation	5.1a replace intake hose
5.2 Dirty air, containing condensation or oil	5.2a Check air line
5.3 Insufficient air flow or pressure	5.3a Check pressure using a pressure gauge installed on the pump when it is running. If the pressure at that point is too low in relation to the network pressure , check all air fittings especially snap-on ones . Check if all air control devices have sufficient flow rate. WARNING: in 90% of cases , stall occurrences are caused by snap-on fittings
5.4 Faulty distributor	5.4a Replace
5.5 Stop procedure not complied with	5.5a Comply with stop procedure

6.Pump does not distribute delivery value started on table

POSSIBLE SOURCE	ADVICE
6.1 Product intake hose is badly connected	6.1 a Check
6.2 Piping is clogged	6.2a Check and clean
6.3 Fluid is too viscous	6.3a Install larger piping especially on the intake side and decrease pump cycles
6.4 Ball do not close properly	6.4a Disassemble the manifolds and clean the seats or both the balls and the ball seats.
6.5 Insufficient air flow	6.5a Check pressure using a pressure gauge installed on the pump when it is running. If the pressure at that point is too low in relation to the network pressure , check all fittings especially snap-on ones. Check if all air control devices have sufficient flow rate. WARNING: in 90% of cases , stall occurrences are caused by snap-on fittings

DECOMMISSIONING

Should the pump remain inactive for long periods, proceed as follows

WARNING; Discharge any residual fluid from the pump. In case of dangerous, toxic fluids and/or otherwise noxious products, wash and treat as suitable: DANGER OF INJURIES. DAMAGE TO HEALTH AND/OR DEATH.

1. Wash internally using products suitable for to the fluid being pumped.
2. Close the fluid intake and delivery valves mounted on the pump.
3. Close the air supply using the three-way valve; this will discharge any residual pressure.
4. If you want to store the pump in the warehouse, you must respect the following:

WARNING: Storage must be in a closed and protected environment at temperatures ranging from 5 to 45C, and a humidity level not above 90%.

5. If the pump was in disuse for a long period of time, circulate clean water through it for some minutes before restarting it to avoid incrustations.

DEMOLITION AND DISPOSAL

The Mini pump does not contain dangerous parts; however, when they are worn out, they must be disposed of in the following manner.

WARNING: Discharge any residual fluid from the pump. In case of dangerous, toxic fluids and/or otherwise noxious products, wash and treat as suitable: danger of injuries, damage to health and/or death.

1. Disconnect pneumatic supply from pump.
2. Disassemble and remove the pump from its position.
3. Separate elements according to type (see the pump's composition codes).

WARNING: For disposal please contact specialized disposal businesses and make sure that no small or large components are dispersed in the environment which may cause pollution, accidents or direct and/or indirect damage.

MINI 005 PLASTIC MADE

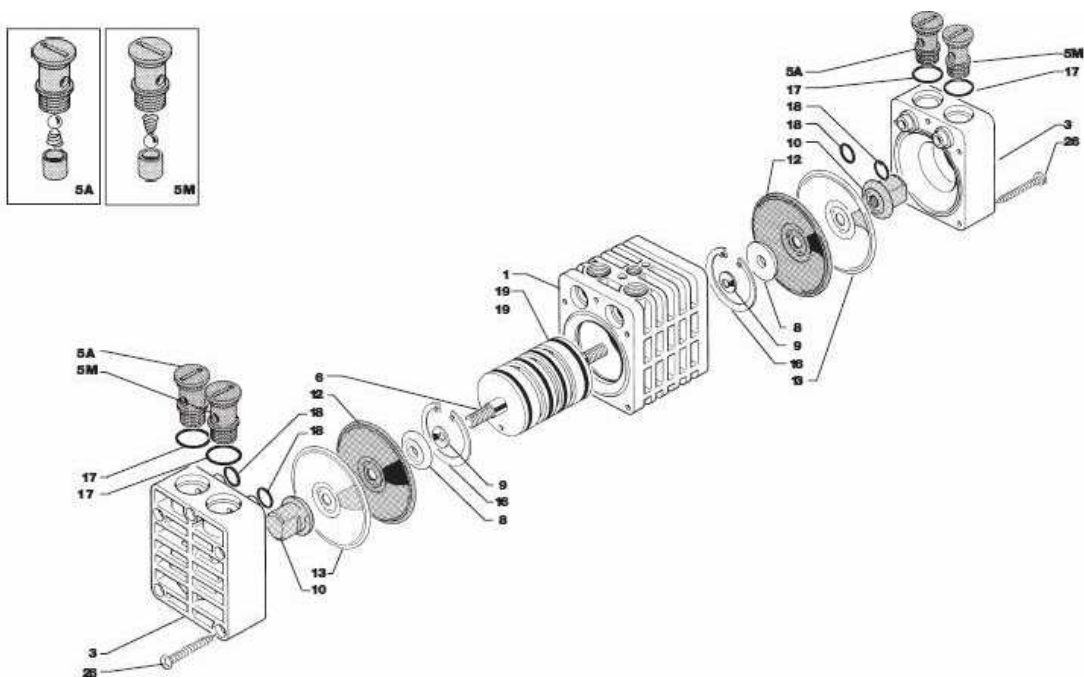

POS	DESCRIPTION
1	Central housing
3	Pump casing
5	Suction and deliv. valves
8	Internal cap
9	External cap
10	Belleville washer
12	Internal diaphragm
13	External diaphragm
16	Stop ring
17	Suction/de valve pack
18	Pump casing packing
6+19	Pneumatic exchanger
26	Pump casing screw

MINI 017 PLASTIC MADE

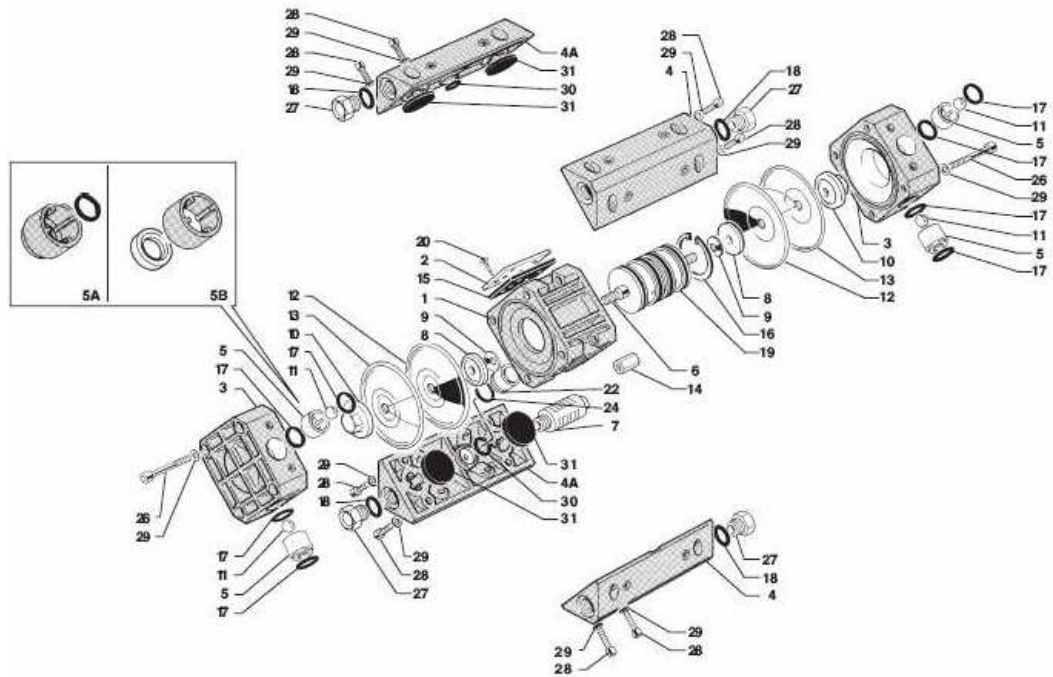

POS	DESCRIPTION
1	Central housing
2	Air exhaust cover
3	Pump casing
4	Deliv. and suct. manifold
4a	Discharge /feed manifold
5	Ball seat
5A e B	Ball seat packing
7	Muffler
8	Internal cap
9	Belleville washer
10	External cap
11	Ball
12	Internal diaphragm
13	External diaphragm
14	Spacer
15	Gasket
16	Stop ring
17	Ball seat packing
18	Manifold cap packing
6+19	Pneumatic exchanger
20	screw
22	Air inject cover
24	O-ring
26	Pump casing screw
27	Manifold cap
28	Manifold screw
29	washer
30	Oring
31	Packing