

eSelect B2/B3



www.etatronds.com

 **ETATRON D.S.**

IT NORME DI INSTALLAZIONE, USO E MANUTENZIONE

UK OPERATING INSTRUCTIONS AND MAINTENANCE



Table of contents

1. GENERAL INFORMATIONS	2
2. TECHNICAL DATA	2
3. CONNECTIONS	3
3.1. eSelect B2 POWER SUPPLY CARD CONNECTIONS	3
3.2. eSelect B2 TTL OUTPUT CONNECTIONS	4
3.3. eSelect B3 POWER SUPPLY CARD CONNECTIONS	5
3.4. eSelect B3 TTL OUTPUT CONNECTIONS	6
3.5. eSelect B2/B3 PROBES CONNECTION	7
4. CONTROL PANEL DESCRIPTION	8
4.1. eSelect B2 CONTROL PANEL	8
4.2. eSelect B3 CONTROL PANEL	8
4.3. LIGHT SIGNS	9
4.4. KEYBOARD	9
5. DIMENSIONS	10
6. PARAMETER DEFAULTS	11
7. PROGRAMMING THE CONTROLLER	12
7.1. STARTING CONTROLLER OPERATION	12
7.2. THE DISPLAY IN THE VARIOUS OPERATION MODES (PH – RX – CL)	14
7.3. PROGRAMMING PROCEDURE	14
7.3.1. SIMPLE MENU MODE	14
7.3.2. EXPERT MENU MODE	15
7.4. PROGRAMMING MENU SETUP	16
7.4.1 MENU MODE	16
7.4.2. MENU METER TYPE	17
7.4.3. T SENSOR	17
7.4.4. SET TEMPERATURE	18
7.4.5. CALIBRATION MENU TIMEOUT	18
7.4.6. DELAY AT STARTUP	18
7.4.7. AUX OUTPUT MODE	19
7.4.8. YEAR, MONTH, DAY, HOUR, MINUTE	20
7.4.9. SET PASSWORD	20
7.4.10. SET DEFAULTS	20
7.5. MENU SETPOINT1, SETPOINT2	21
7.5.1. SETPOINT	22
7.5.2. MODE	22
7.5.3. HYSTERESIS	22
7.5.4. SETPOINT DELAY	22
7.5.5. TTL MODE	23
7.5.6. METER READING @4mA	23
7.5.7. METER READING @20mA	23
7.6. MENU CALIBRATION	24
7.6.1. CALIBRATE pH 7/REF.POINT	25
7.7. MENU ALARM	25
7.7.1. MENU ALARM SETTINGS	26
8. INPUT/OUTPUT CONNECTIONS	26
8.1. PROXIMITY SENSORS	26
8.2. PT100 CONNECTION	27

1. GENERAL INFORMATIONS



Electronic instruments controlling electrochemical parameters such as pH, Redox or Chlorine are widely used in swimming pools, waterworks and water treatment plants.

The eSelect Series Controllers stand out for the following features:

- Capability of performing the most possible measurements with just one type of electronic board: pH, Redox (mV), Cl (ppm).
- Simple and easy to learn programming procedure providing two types of menu: a **SIMPLE** menu allowing the user to control indispensable functions, and a **EXPERT** menu giving the user the full capability of setting all functions.
- Galvanically isolated electronics providing a high level of immunity to disturbances.

2. TECHNICAL DATA

Parameter	Value	
Input Voltage	90-240 Vac 50/60Hz, 12-24 Vdc, 24Vac	
Power Consumption	15 W (1 A peak current)	
Operating temperature range	0 – 40°C	
SETPOINT relay output terminals max current	16 ampere with resistive load 3 ampere with inductive load	2 setpoints
Auxiliary relay output terminals max current	5 ampere with resistive load 0.7 ampere with inductive load	1 auxiliary output
Alarm relay output terminals max current	5 ampere with resistive load 0.7 ampere with inductive load	1 alarm output
Current output	4 - 20 mA (dynamic 0..500 Ω)	2 current outputs
TTL output	0 – 999 pulse/min	2 open collector TTL outputs
pH range	0 ... 14	0.01 pH resolution
Rx range (mV)	-1000+1400	± 1 mV Rx resolution
Chlorine range	0÷2; 0÷20; 0÷200; 0÷2000 ppm	0,001/0,01/0,1/1 ppm
Temperature range	0 – 100°C	0.1°C
Level control – PT100 connection – Relay output 6A (resistive load) 1A (inductive load)		

3.1. eSelect B2 POWER SUPPLY CARD CONNECTIONS

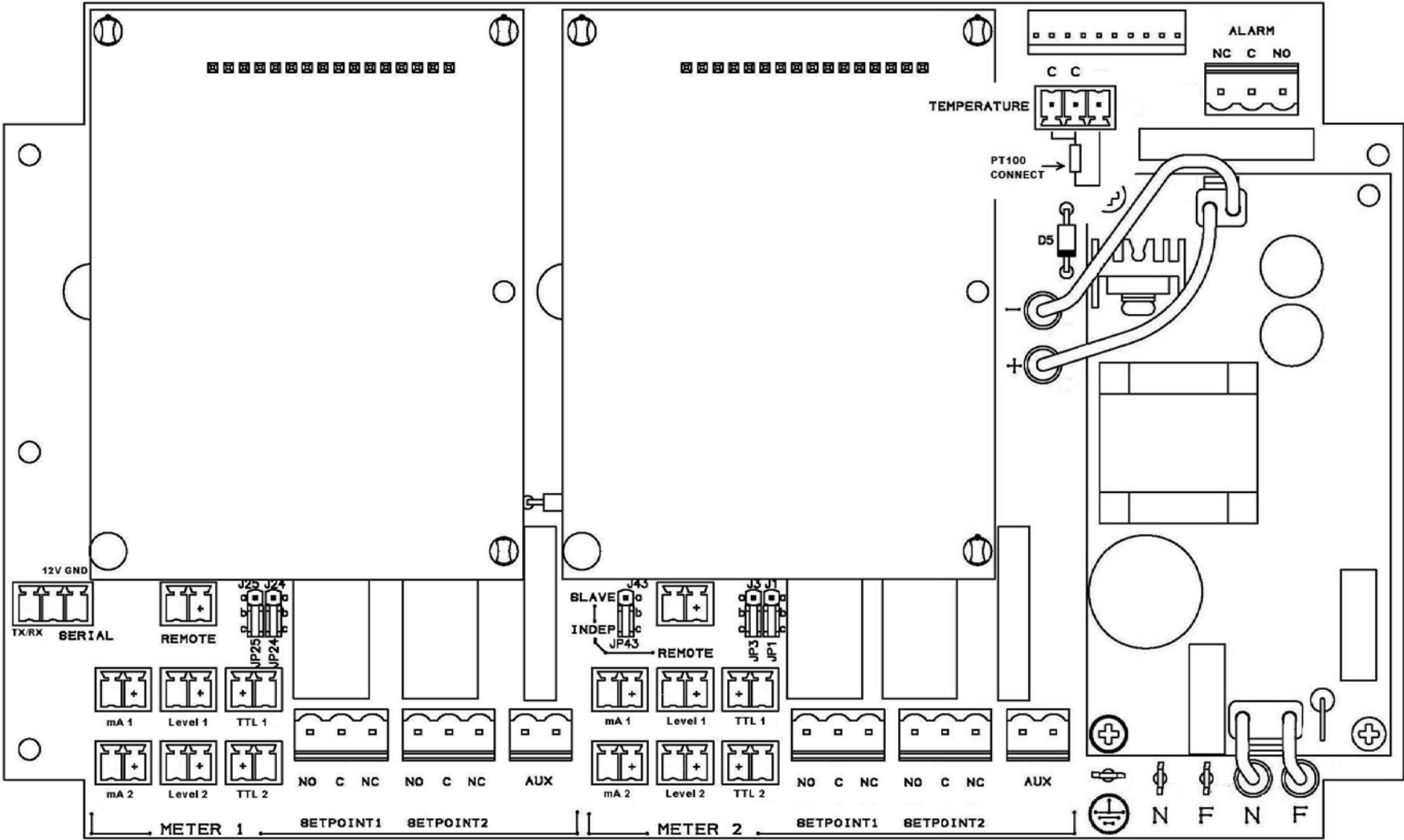

3.2. eSelect B2 TTL OUTPUT CONNECTIONS

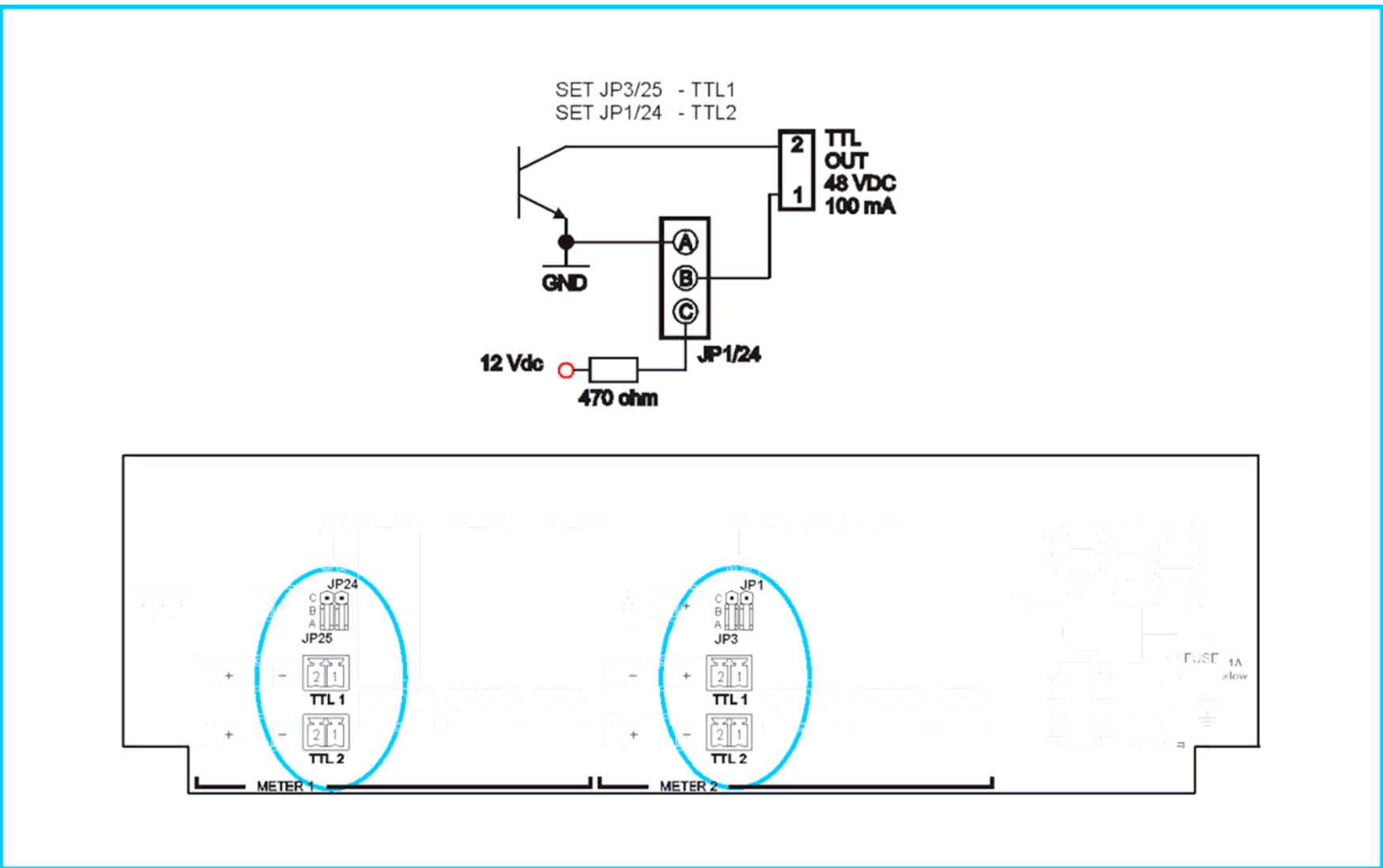

3.3. eSelect B3 POWER SUPPLY CARD CONNECTIONS

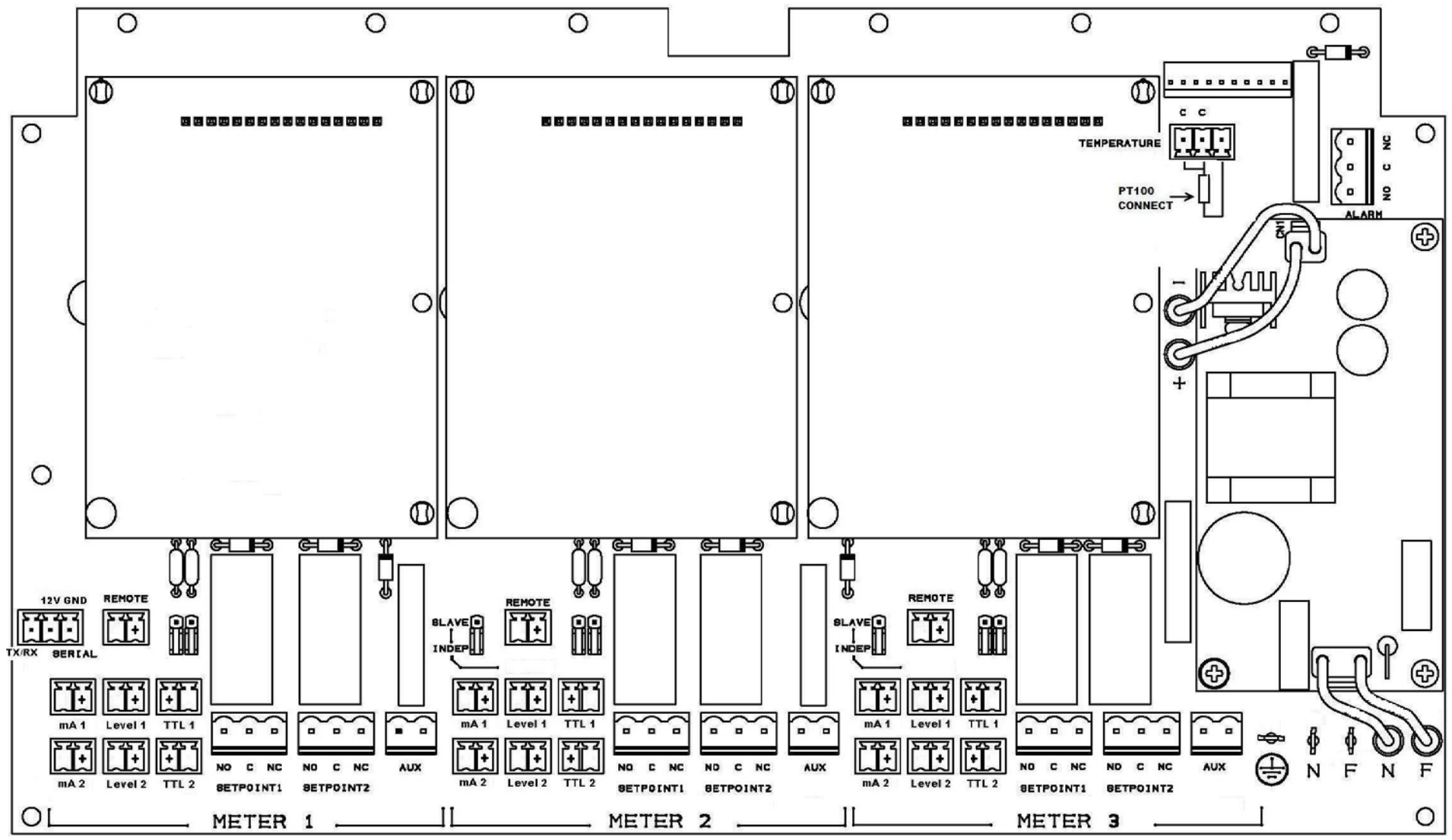

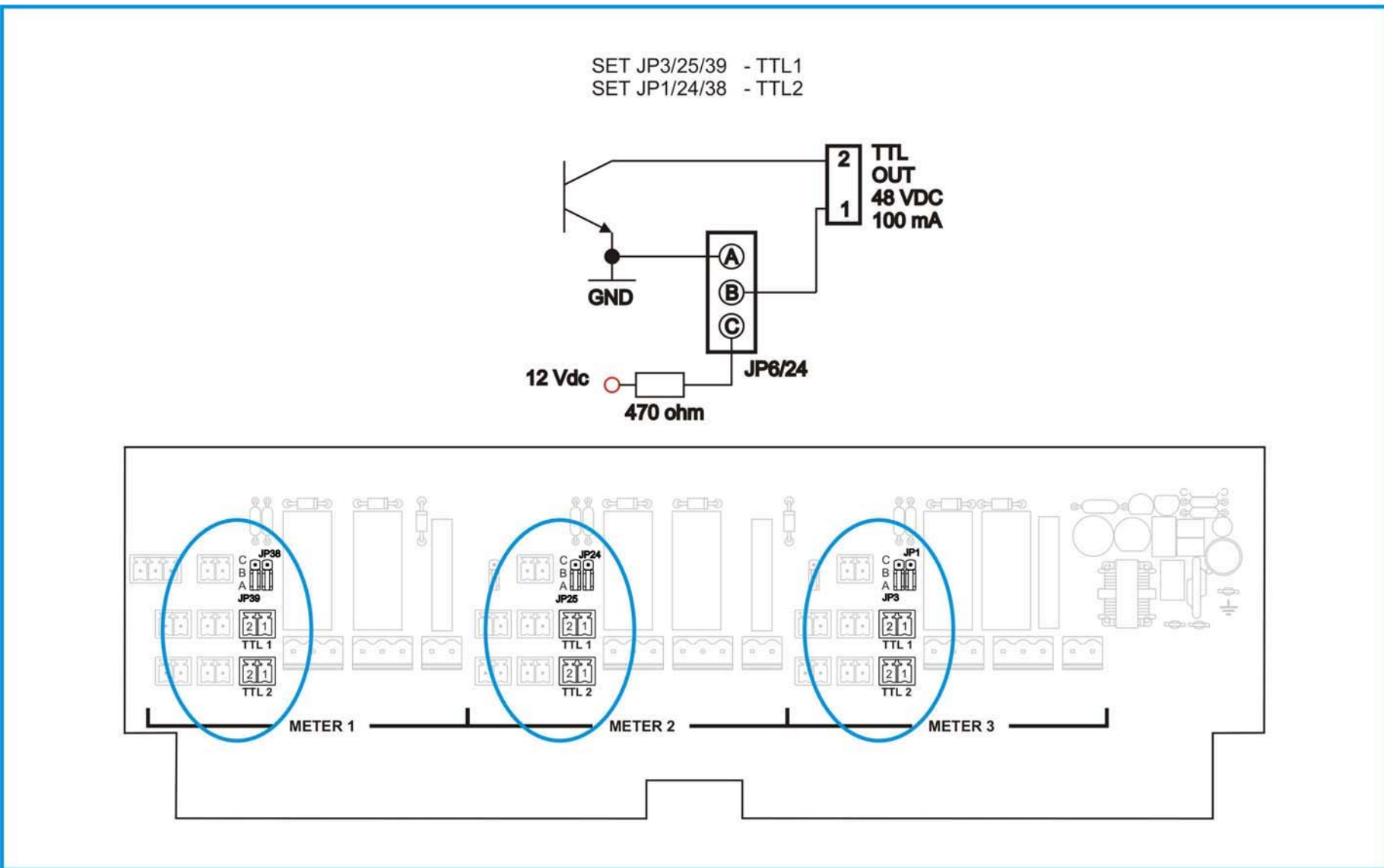

3.5. eSelect B2/B3 PROBES CONNECTION

A BNC connector for connecting pH or Redox probes, plus a 4-pin connector for connecting a Chlorine probe, are provided in the bottom of the instrument. The connection diagram is as follows:

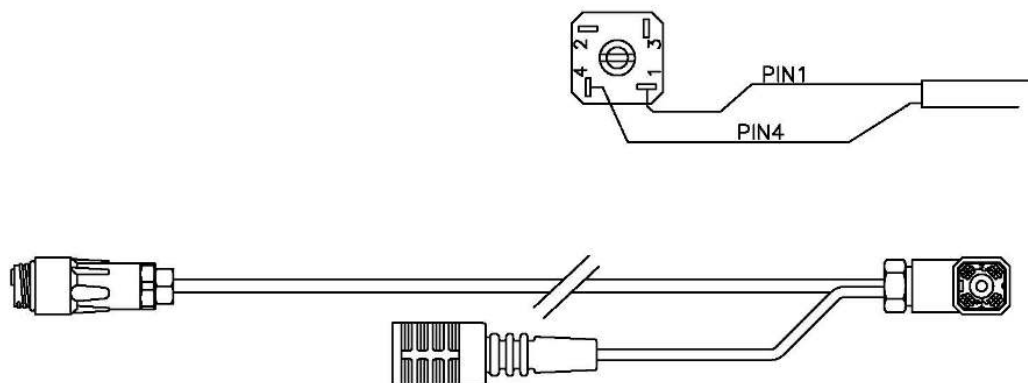

Power supply 4 pins connector:

- Pin 1 : Brown (+5V)
- Pin 2 : Not connected
- Pin 3 : Not connected
- Pin 4 : White (-5V)

BNC connector:

- Central conductor : Green (signal)
- Shield : Yellow (GND)

4. CONTROL PANEL DESCRIPTION



4.1. eSelect B2 CONTROL PANEL



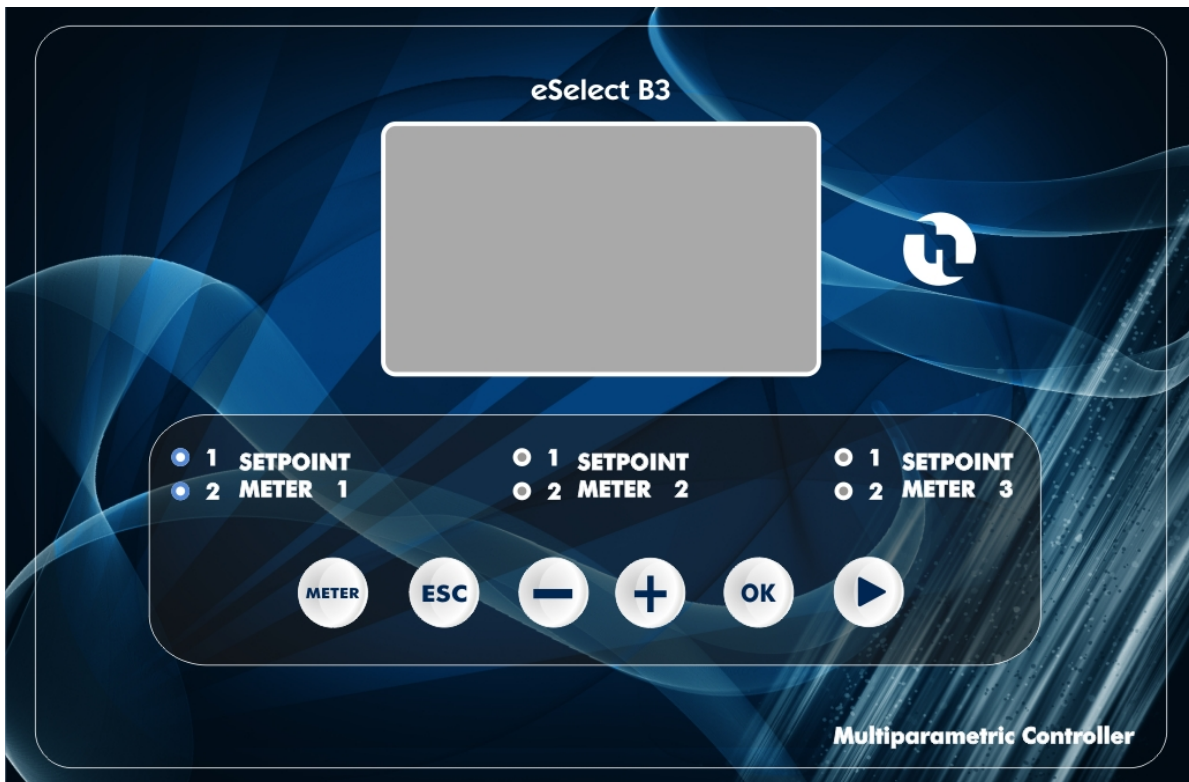





4.2. eSelect B3 CONTROL PANEL



4.3. LIGHT SIGNS

 <p>The image shows a dark blue rectangular panel with the word "SETPOINT" in white capital letters. To the left of the text are two circular indicators. The top indicator is labeled "1" and has a red center. The bottom indicator is labeled "2" and has a white center.</p>	<p>SET 1 active</p>
 <p>The image shows a dark blue rectangular panel with the word "SETPOINT" in white capital letters. To the left of the text are two circular indicators. The top indicator is labeled "1" and has a white center. The bottom indicator is labeled "2" and has a red center.</p>	<p>SET 2 active</p>

4.4. KEYBOARD

 <p>A square button with a blue background and a black border, containing the word "METER" in white capital letters.</p>	<p>Meter : Used to select the type of measurement “METER 1, 2 or 3”</p>
 <p>A square button with a blue background and a black border, containing the letters "ESC" in white capital letters.</p>	<p>ESC : Comes one step back in the programming procedure.</p>
 <p>A square button with a blue background and a black border, containing a white minus sign.</p>	<p>Minus symbol : Decreases numbers and defines functions within specific programming menus. E.g.: when selecting the type of measurement allows the user to shift between pH, Rx and Chlorine.</p>
 <p>A square button with a blue background and a black border, containing a white plus sign.</p>	<p>Plus symbol : Increases numbers and defines functions within specific programming menus. E.g.: when selecting the type of measurement allows the user to shift between pH, Rx and Chlorine.</p>
 <p>A square button with a blue background and a black border, containing a white right-pointing triangle.</p>	<p>Shift right : Used to select the digit to modify when setting passwords. Used to change Language also.</p>
 <p>A square button with a blue background and a black border, containing the letters "OK" in white capital letters.</p>	<p>OK : Allows the user to proceed by confirming the selections made.</p>

5. DIMENSIONS

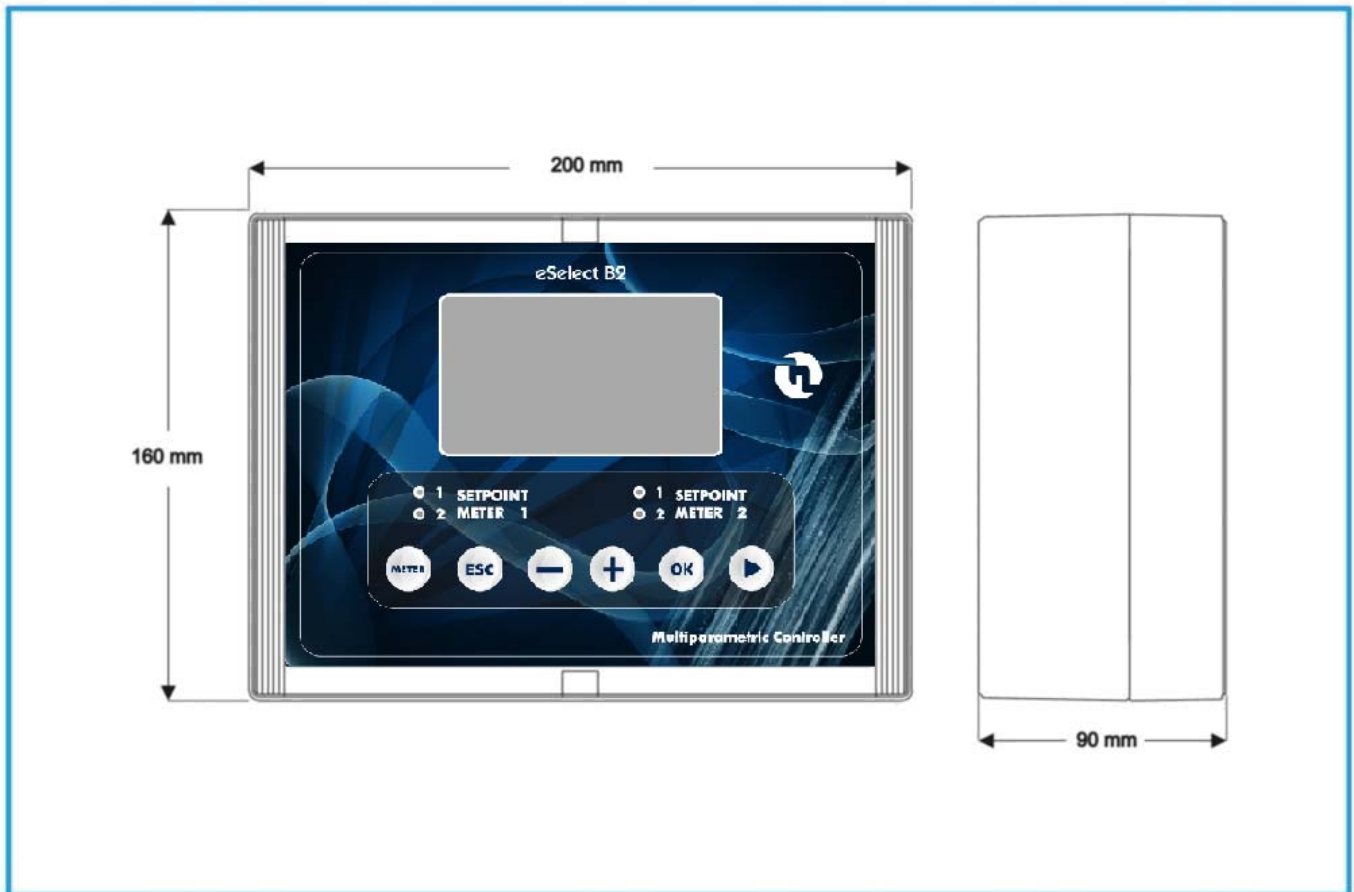

6. PARAMETER DEFAULTS

No.	Function	pH default	Rx default mV	Cl default
1	Setpoint 1	7.2	650	1
2	Setpoint 2	6.8	400	1
3	Type of action	Acid for Setpoint 1 Alk for Setpoint 2	Down for Setpoint 1 Up for Setpoint 2	UP
4	Hysteresis	0.10	10	0.05
5	SETPOINT 1 and 2 actuation delay	00:03 m:s	00:03 m:s	00:03 m:s
6	TTL 1 and 2 outputs max frequency	120	120	120
7	Measurement at TTL 1 and 2 max frequency	14.00	1000	1
8	mA output 1 and 2, measurement at 4 mA	0.00	0	0.000
9	mA output 1 and 2, measurement at 20 mA	14.00	1000	1.000
10	Alarm – max value	14.00	1000	10
11	Alarm – min value	0.00	0	0.000
12	Alarm – overdosing TIME	99:59 h:m	99:59 h:m	99:59 h:m
13	Menu mode	SIMPLE	SIMPLE	SIMPLE
14	Password	OFF	OFF	OFF
15	Temperature unit	°C	°C	°C
16	Temperature compensation mode	Manual 25°C	Manual 25°C	Manual 25°C
17	Calibration menu TIMEOUT	5'	5'	5'
18	Delay at STARTUP	5"	5"	5"

7. PROGRAMMING THE CONTROLLER

All programming parameters and modes of operation of the instrument can be set using its keyboard and dedicated display.

7.1. STARTING CONTROLLER OPERATION

The instrument, according to its initial configuration, can be set to control three distinct types of measurements: pH, Rx or Chlorine.

To perform that, when switching on the controller for the first time, the operator have to select the intended type of measurement by operating as follows:

Upon switching on the instrument, press OK key to enter in the MENU SETUP.

Then press OK to enter in MENU MODE and change SIMPLE with EXPERT by press + or – key.

Then change the METER TYPE in the complete MENU SETUP.

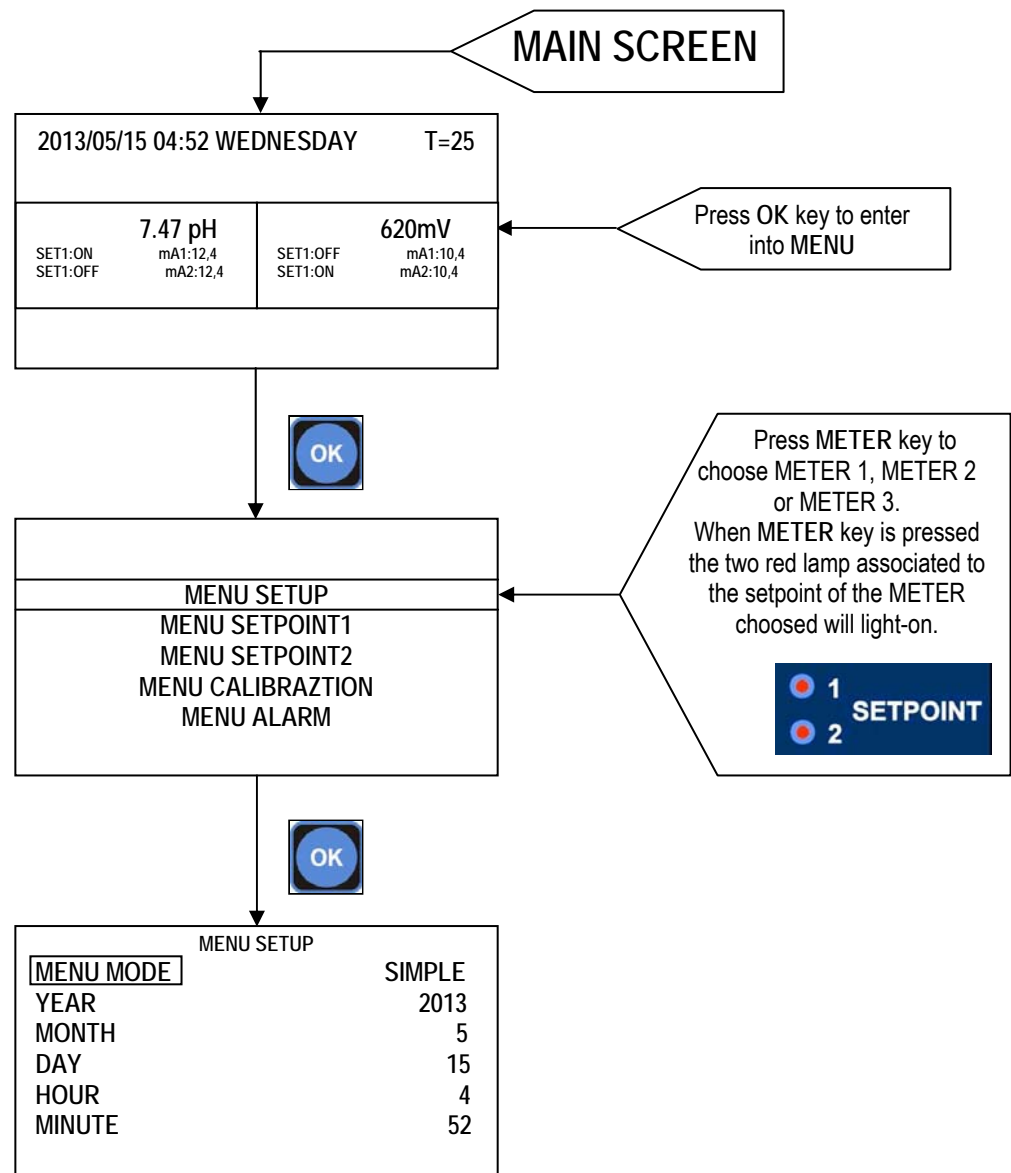

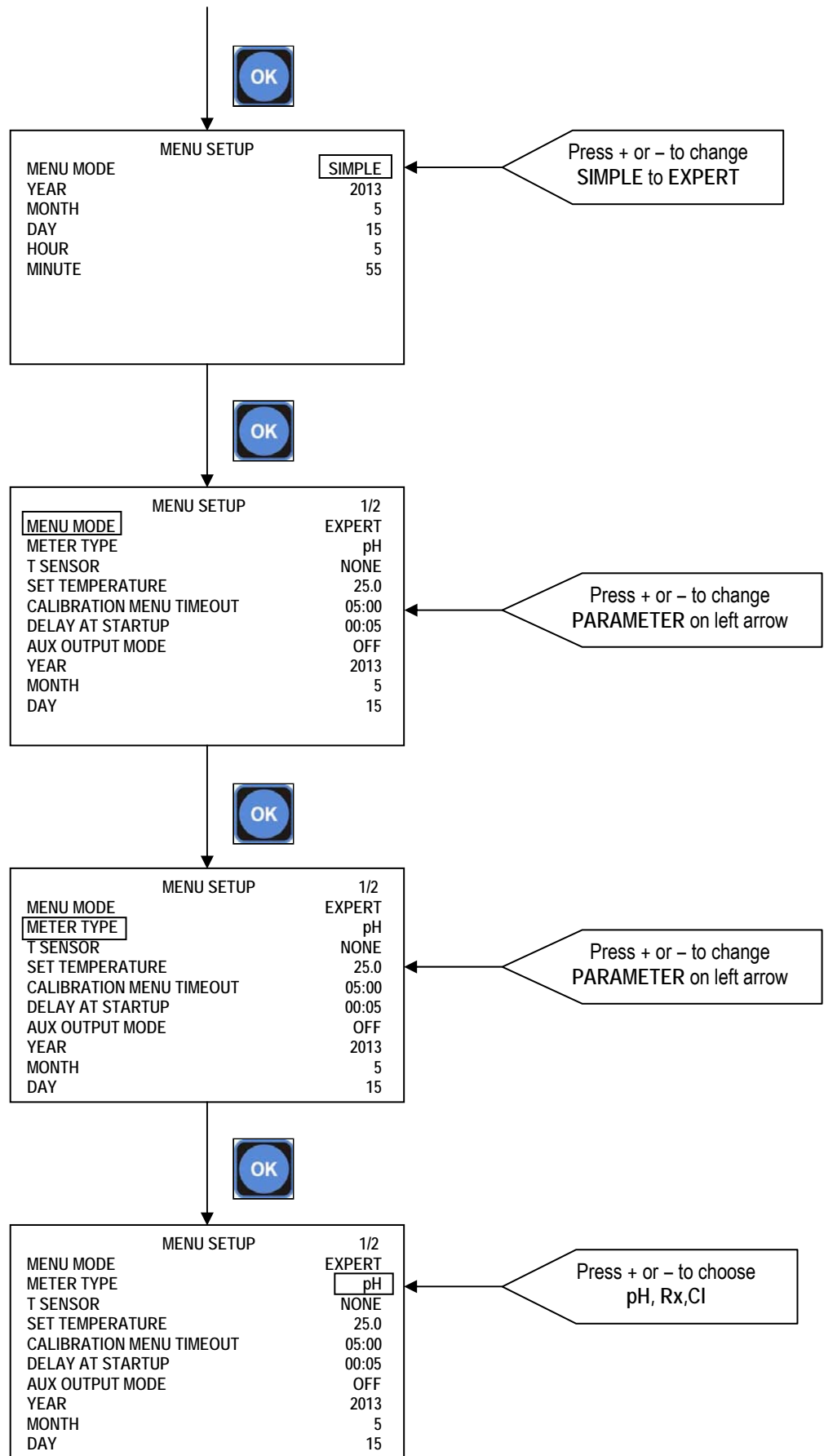

After choose the METER TYPE press ESC key until see the main screen.
Please note the ESC key permits to return to previous screen.

7.2. THE DISPLAY IN THE VARIOUS OPERATION MODES (PH – RX – CL)

When the instrument is switched on, the display shows the measurement value and the type of measurement.

2013/05/15 04:52 WEDNESDAY		T=25
7.47 pH	620mV	
SET1:ON SET1:OFF	mA1:12.4 mA2:12.4	SET1:OFF SET1:OFF mA1:4.0 mA2:4.0
METER 2: STANDBY		

eSelect B2 main screen

2013/05/15 04:52 WEDNESDAY		T=25			
7.47 pH	11.63 Cl ppm				
SET1:ON SET1:OFF	mA1:12.4 mA2:12.4	SET1:OFF SET1:ON mA1:10.4 mA2:10.4			
<table border="1" style="margin: auto;"> <tr> <td>620mV</td> </tr> <tr> <td>SET1:OFF SET1:ON</td> </tr> <tr> <td>mA1:10.4 mA2:10.4</td> </tr> </table>			620mV	SET1:OFF SET1:ON	mA1:10.4 mA2:10.4
620mV					
SET1:OFF SET1:ON					
mA1:10.4 mA2:10.4					
METER 3: ALARM: MAX					

eSelect B3 main screen

7.3. PROGRAMMING PROCEDURE

When installing the controller for the first time, the user must configure it depending on the intended type of measurement or control.

The first action for the user to carry out is setting the operation modes for every measurement outlet: METER 1 and METER 2 for B2 controller, and METER 1, METER 2 and METER 3 for B3 controller.

When setting the instrument, it is advisable to follow the programming procedure outlined below. Conversely, if only a single parameter must be changed, it is advisable to go directly to the menu comprising the concerned function, and perform the necessary changes or settings.

Please note there are two different MENU MODE: SIMPLE and EXPERT and they allow to change different parameters. EXPERT MENU allow to change all parameters but it is recommended to modify its parameters from qualified personnel.

7.3.1. SIMPLE MENU MODE

MENU SETUP		SIMPLE
MENU MODE		
YEAR		2013
MONTH		5
DAY		15
HOUR		4
MINUTE		52

It permits to set the following parameters:

- MENU MODE: SIMPLE or EXPERT
- YEAR: put the current YEAR
- MONTH: put the current MONTH
- DAY: put the current DAY
- HOUR: put the current HOUR
- MINUTE: put the current MINUTE

7.3.2. EXPERT MENU MODE

MENU SETUP		1/2
MENU MODE		EXPERT
METER TYPE		pH
T SENSOR		NONE
SET TEMPERATURE		25
CALIBRATION MENU TIMEOUT		05:00
DELAY AT STARTUP		00:05
AUX OUTPUT MODE		OFF
YEAR		2013
MONTH		5
DAY		15

MENU SETUP		2/2
HOUR		14
MINUTE		52
SET PASSWORD		0 0 0 0 0 0
SET DEFAULTS		NO

It permits to set the following parameters by use :

- MENU MODE: SIMPLE or EXPERT
- METER TYPE: pH, Rx, Cl 20ppm, Cl 2ppm, Cl 200ppm, Cl 2000ppm
- TSENSOR: NONE or PT100
- SET TEMPERATURE: put the current TEMPERATURE is PT100 is not setted
- CALIBRATION MENU TIMEOUT: set the TIMEOUT time for CALIBRATION procedure
- DELAY AT STARTUP: set the startup DELAY TIME for the instrument
- AUX OUTPUT MODE: set OFF or CLEANING or FLOCCULANT
- YEAR: put the current YEAR
- MONTH: put the current MONTH
- DAY: put the current DAY
- HOUR: put the current HOUR
- MINUTE: put the current MINUTE
- SET PASSWORD: put the password if it is necessary to have it
- SET DEFAULTS: set NO or MAINTAIN CALIBRATION or RESTORE ALL

7.4. PROGRAMMING MENU SETUP

7.4.1 MENU MODE

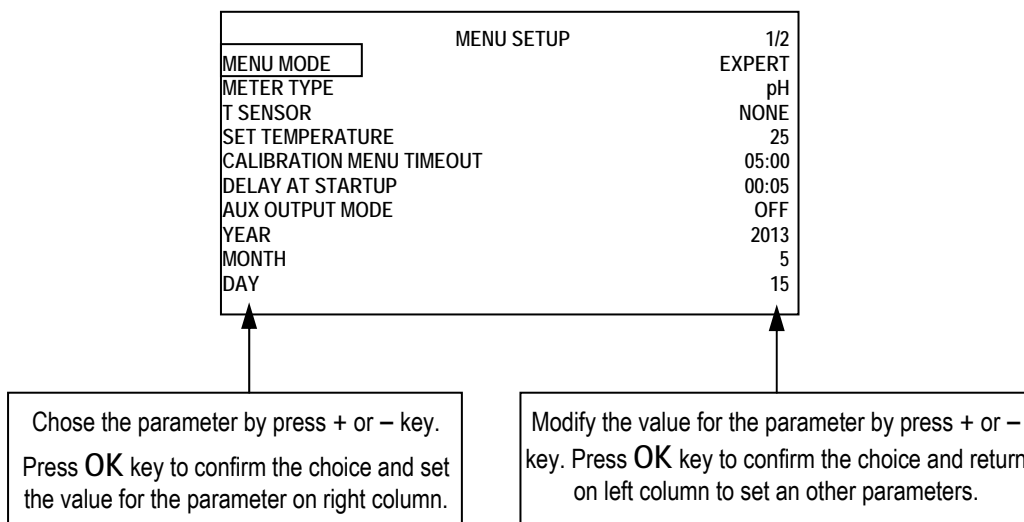

Starting from the MAIN SCREEN press OK key until enter in MENU MODE.

Than change SIMPLE to EXPERT by pressing + key or – key.

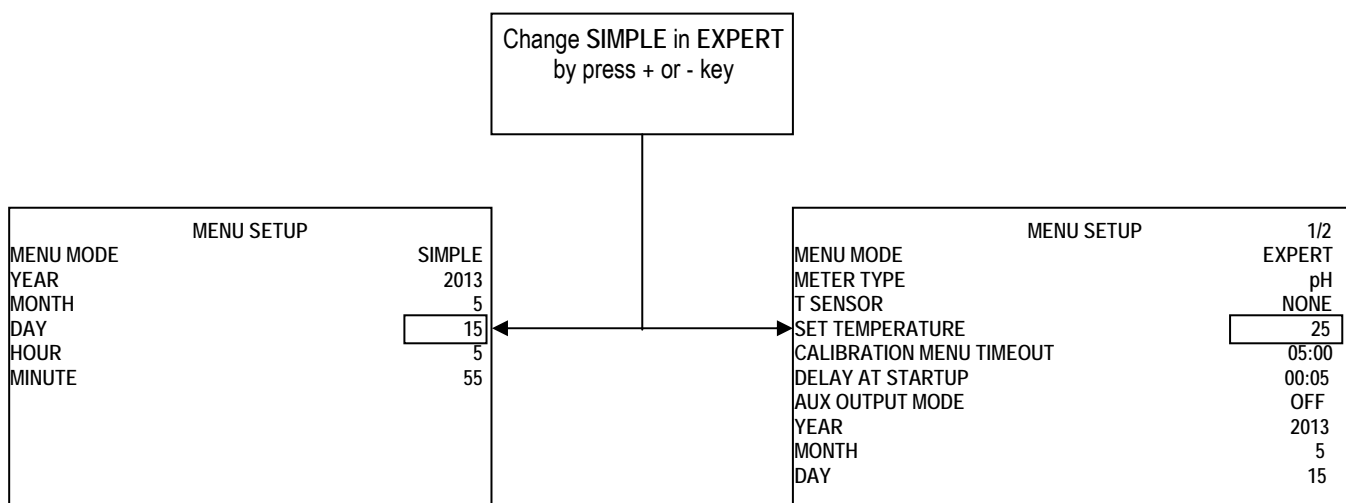

7.4.2. MENU METER TYPE

Starting from the MENU SETUP screen, enter in METER TYPE by pressing + key or – key. After selected METER TYPE press OK key to set the meter type between pH, Rx, Cl 20ppm, Cl 2ppm, Cl 200ppm, Cl 2000ppm.

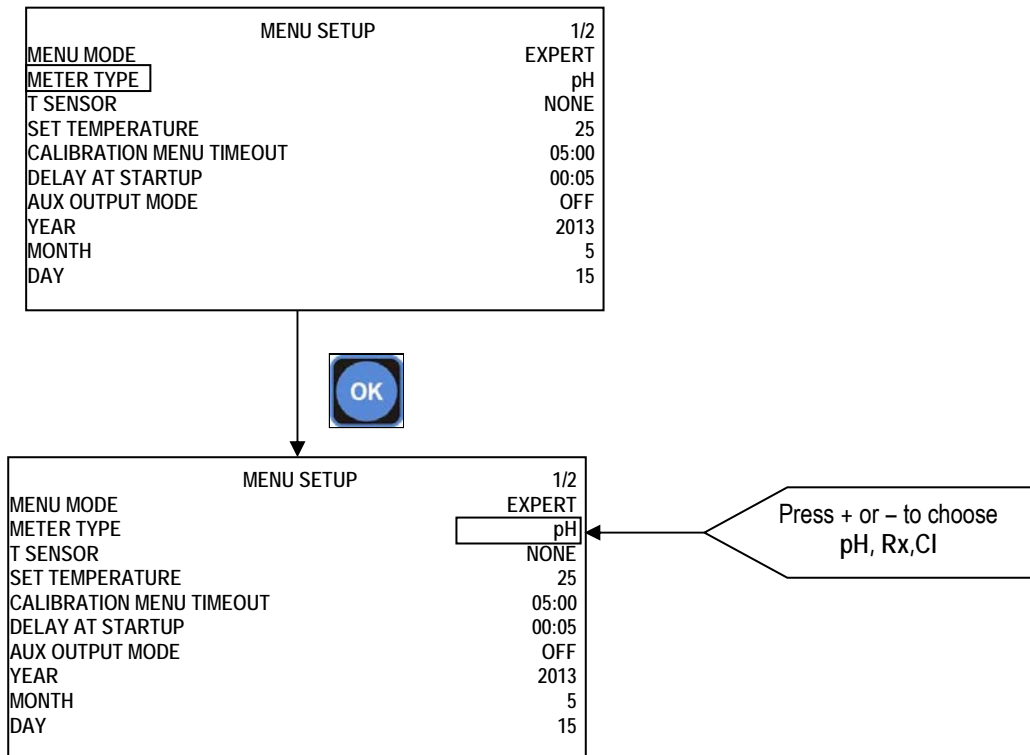

7.4.3. T SENSOR

Starting from the MENU SETUP screen, enter in T SENSOR by pressing + key or – key. After selected T SENSOR press OK key to set or not PT100 sensor.

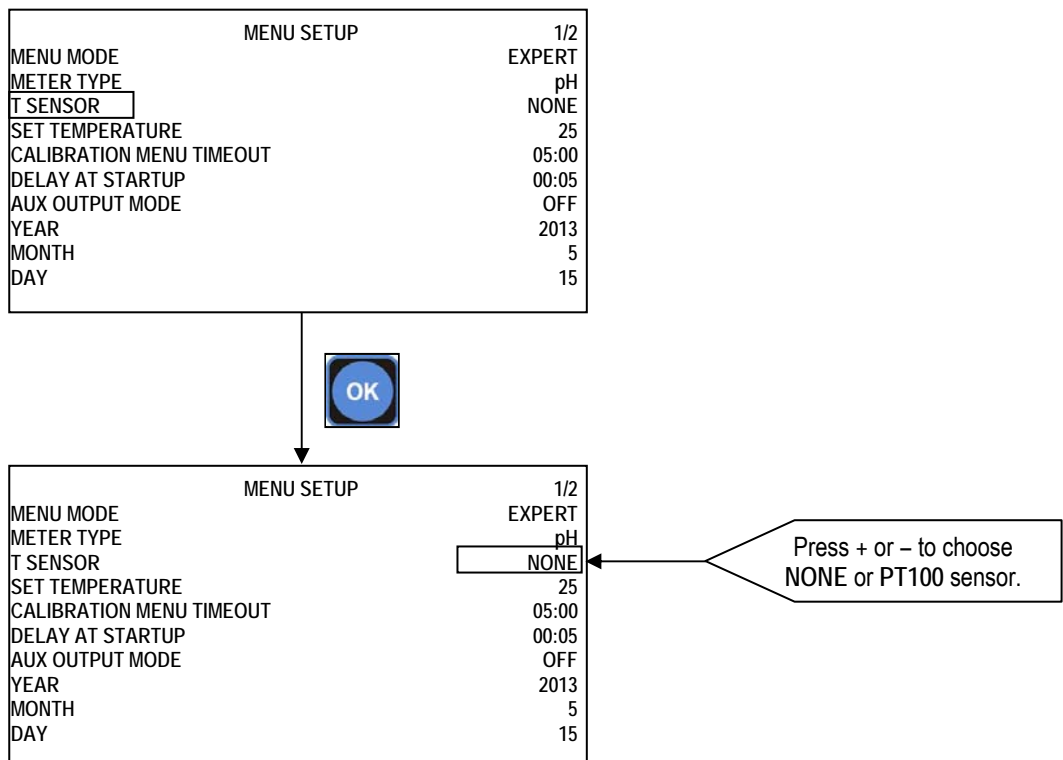

If PT100 will be set a PT100 sensor have to be connected to the dedicated connector. Selecting PT function, the temperature measured by PT100 probe is shown on the display (while the visualization of the measure is in progress).

If NONE will be set it is possible to set the real temperature as show in next paragraph.

7.4.4. SET TEMPERATURE

Starting from the MENU SETUP screen, if the PT100 sensor is not setted, enter in SET TEMPERATURE menu by pressing + key or – key.

After selected SET TEMPERATURE press OK key to set the temperature value.

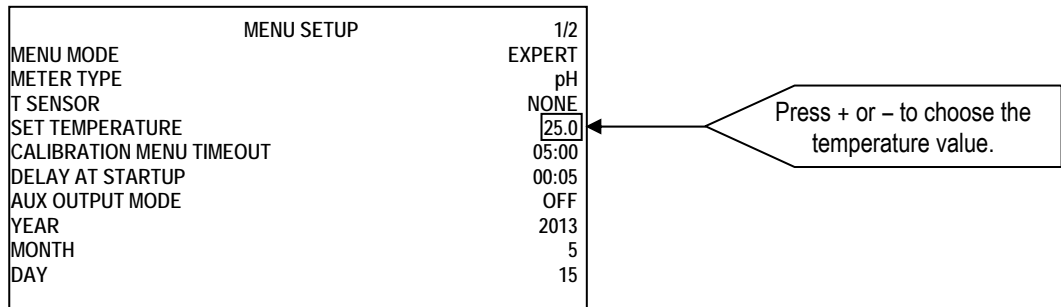

7.4.5. CALIBRATION MENU TIMEOUT

It represent the exit delay time from the programming menu in case no keys are pressed during the probe calibration stage.

Starting from the MENU SETUP screen, enter in CALIBRATION MENU TIMEOUT by pressing + key or – key.

After selected CALIBRATION MENU TIMEOUT press OK key to set the time value.

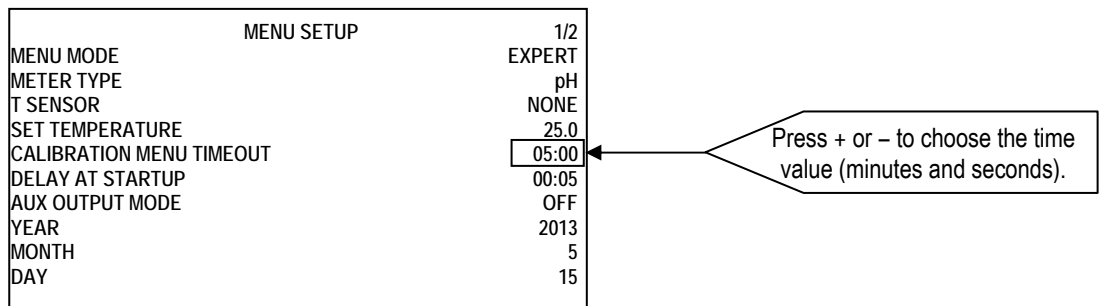

7.4.6. DELAY AT STARTUP

It define the delay time of measurement actuation from switching on the instrument.

Starting from the MENU SETUP screen, enter in DELAY AT STARTUP by pressing + key or – key.

After selected DELAY AT STARTUP press OK key to set the time value.

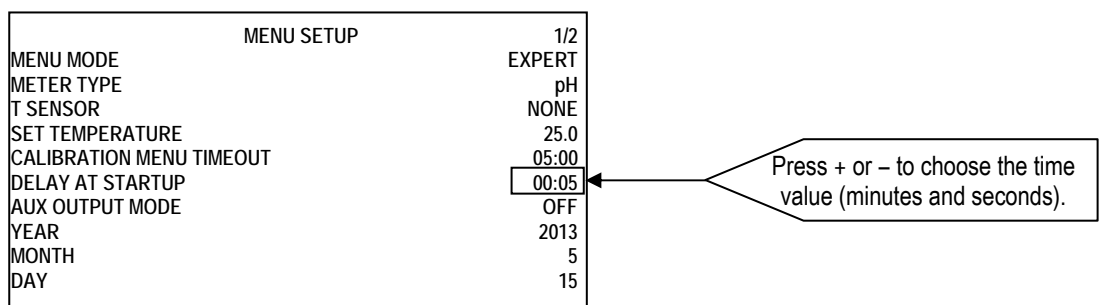

7.4.7. AUX OUTPUT MODE

The controller has a calendar and an internal clock for the management of the exits with timer and the storage of the data recorded by the controller; in order to set up the clock the following settings must be carried out.

Once the date and time are set, by pressing the + or - key, the choice are the follow:

- **OFF** function: the aux output is deactivated;
- **Cleaning** function: it is possible to activate a dosing pump for the cleaning of the electrode, up to a maximum of 4 interventions (timer and scheduled mode) during the day; the difference from the flocculant mode, is that the Cleaning mode interrupts the tool's operations (disabling the set-point). At the end of such intervention the tool awaits the start up time (see DELAY AT STARTUP).
- **Flocculant** function: it is possible to activate the flocculant dosing system, up to a maximum of 4 interventions (timer and scheduled mode) during the day.

Starting from the MENU SETUP screen, enter in AUX OUTPUT MODE by pressing + key or - key.

After selected AUX OUTPUT MODE press OK key to set between OFF, CLEANING and FLOCCULANT.

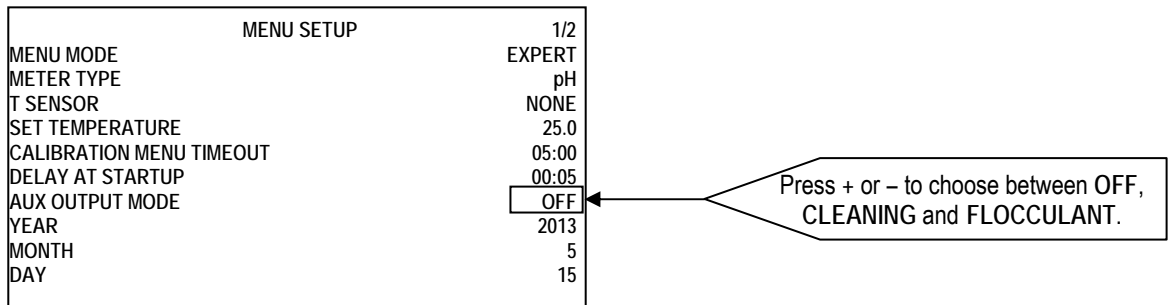

Once one of the two functions is activated (flocculant or cleaning) it is necessary to set the auxiliary outputs that need to be activated by select the days in which the auxiliary output needs to be activated.

7.4.7.1. CLEANING AUX OUTPUT MODE

Starting from the MENU SETUP screen, and selected CLEANING as AUX OUTPUT MODE press OK key.

Then Set CYCLE TIME, WEEKDAYS1, WEEKDAYS2, WEEKDAYS3, WEEKDAYS4 as follow:

- **CYCLE TIME**: define how long time the AUX OUTPUT relay have to be activated;
- **WEEKDAYS1, WEEKDAYS2, WEEKDAYS3, WEEKDAYS4** : define the days of the week in wich the aux output have to be activated; after setting the WEEKDAYS on the display appear to set the **START TIME**

7.4.7.2. FLOCCULANT AUX OUTPUT MODE

Starting from the MENU SETUP screen, and selected FLOCCULANT as AUX OUTPUT MODE press OK key.

Then Set CYCLE TIME, WEEKDAYS1, WEEKDAYS2, WEEKDAYS3, WEEKDAYS4 as follow:

- **CYCLE TIME**: define how long time the AUX OUTPUT relay have to be activated;
- **WEEKDAYS1, WEEKDAYS2, WEEKDAYS3, WEEKDAYS4** : define the days of the week in wich the aux output have to be activated; after setting the WEEKDAYS on the display appear to set the **START TIME**

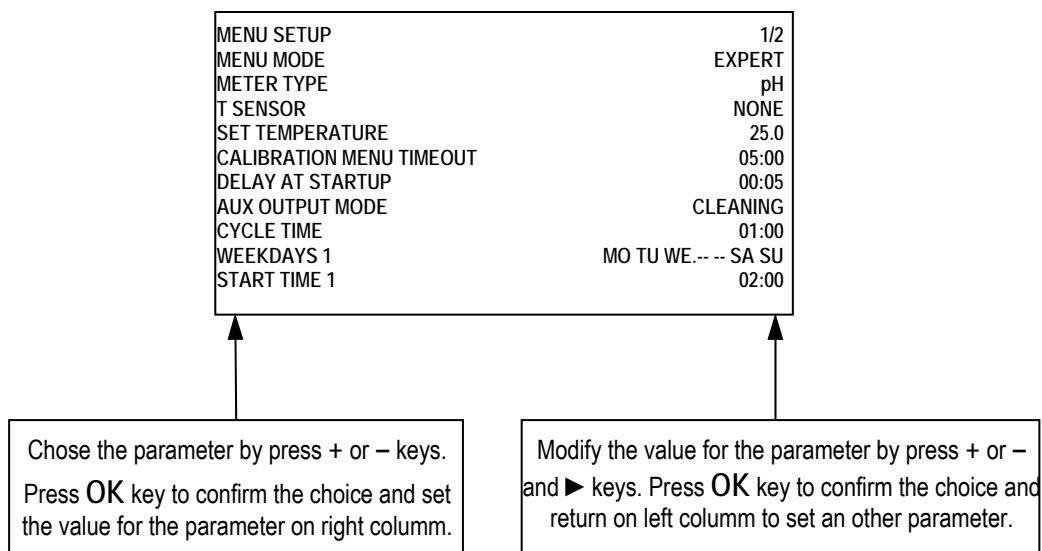

7.4.8. YEAR, MONTH, DAY, HOUR, MINUTE

Starting from the MENU SETUP screen, enter in YEAR or MONTH or DAY or HOUR or MINUTE by pressing + key or – key. For each of these parameters press press OK key and set the value on right column.

7.4.9. SET PASSWORD

As soon as the measurement is selected, proceeding within the SETUP menu, the user can decide to activate the password security and the relating 6 digits code. The password can be any number between 000000 and 999999.

To set the value, for any digit use + or – key and move to the next digit by press ► key.

After setting all 6 digit press OK key to set the next parameter.

7.4.10. SET DEFAULTS

Starting from the MENU SETUP screen, enter in SET DEFAULT by pressing + key or – key. Than press OK key and set one of the followings:

- NO: to don't reset the parameters;
- MAINTAIN CALIBRATION: to reset all parameters and save only the calibration;
- RESTORE ALL: to reset all parameters.

7.5. MENU SETPOINT1, SETPOINT2

Starting from the MAIN SCREEN in EXPERT MENU MODE press OK key than press + key to move the selector on MENU SETPOINT1 or MENU SETPOINT2. Press OK key to enter.

Please note starting from SIMPLE MENU MODE into the SETPOINT1 and SETPOINT2 it is possible to set only the SETPOINT value and the working MODE (acid or alkaline).

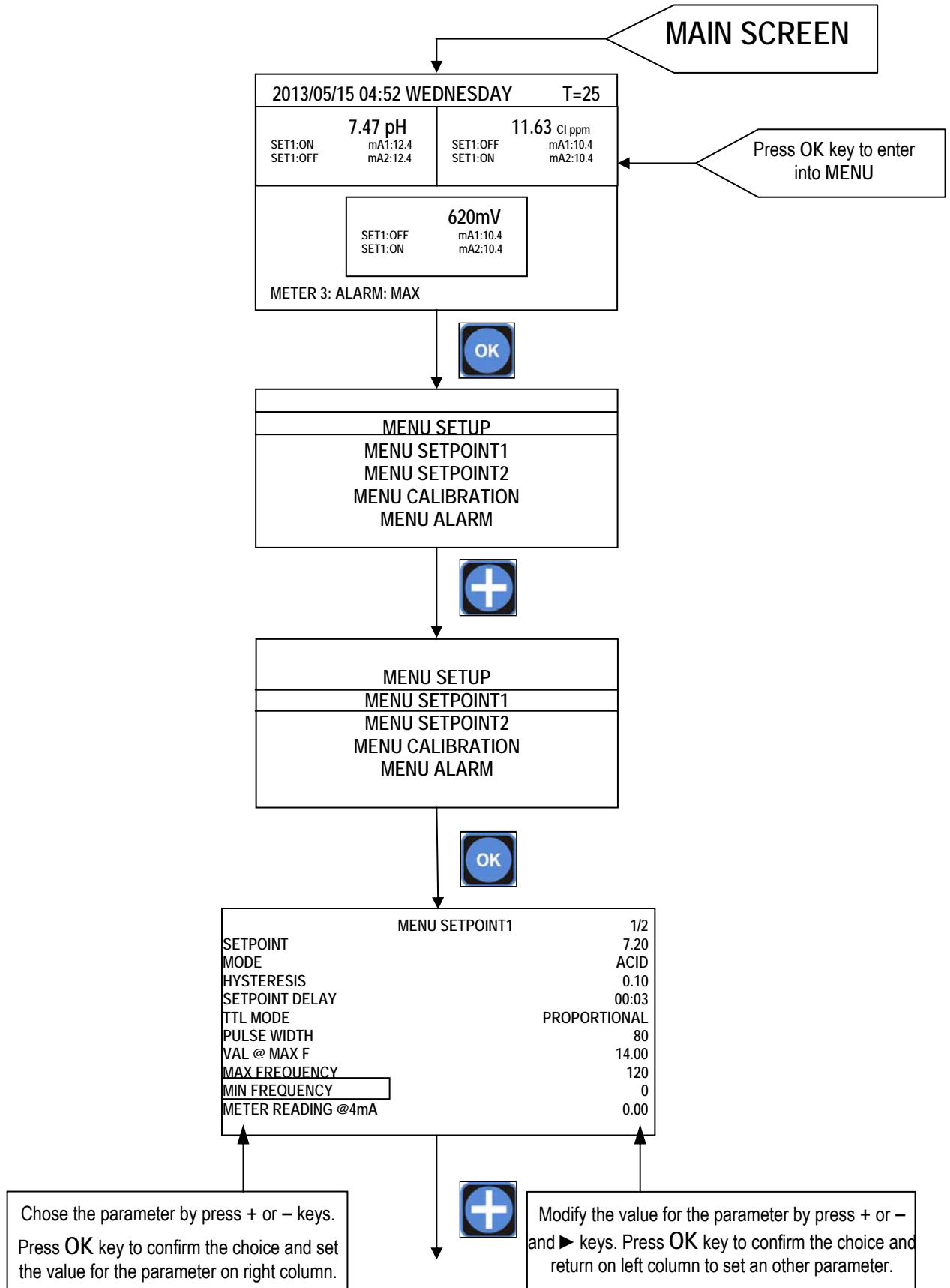

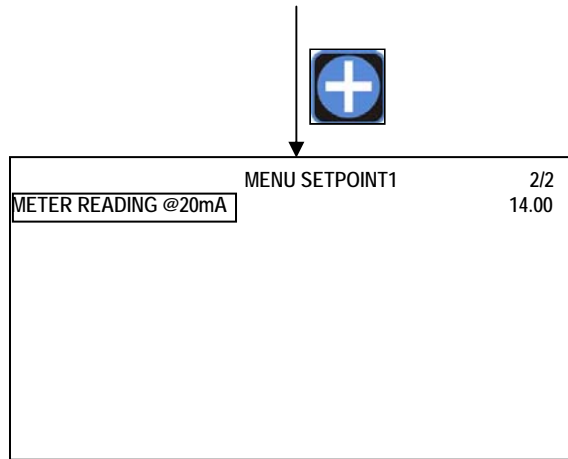

7.5.1. SETPOINT

After setting up the instrument, the SETPOINT values must be set: the instrument features two independent SETPOINTS (SETPOINT1 and SETPOINT2) actuating two relating relay outputs.

On the previous screen is show how set the values for these setpoints. After set the SETPOINT parameter, press OK key to move the cursor on right column and set the value by press + or – keys.

After set the setpoint value press OK key to confirm.

7.5.2. MODE

Defining the type of actuation: ACID or ALKALINE in the case of pH, DOWN and UP in the case of REDOX and CL; they represents the action tends to decrease or increase the measurement.

After set the MODE parameter, press OK key to move the cursor on right column and set the value by press + or – keys.

Press OK key to confirm the setted value.

7.5.3. HYSTERESIS

After defining the type of actuation, setting the hysteresis value is the next step.

After set the HYSTERESIS parameter, press OK key to move the cursor on right column and set the value by press + or – keys.

Press OK key to confirm the setted HYSTERESIS value.

7.5.4. SETPOINT DELAY

The instrument allows the user to define a delay time relating to SETPOINT actuation.

After set the SETPOINT DELAY parameter, press OK key to move the cursor on right column and set the value by press + or – keys. Use the ► key to move from minutes to seconds. Press OK key to confirm the setted SETPOINT DELAY time.

7.5.5. TTL MODE

The instrument features two TTL (1-2) outputs that can operate in the **PROPORTIONAL** or **ON/OFF** mode. After set the **TTL MODE** parameter, press **OK** key to choose the operation mode of the TTL output selected: **PROPORTIONAL** or **ON/OFF**. In the proportional mode the frequency of pulses decreases approaching the **SETPOINT** until the minimum set value is reached, whilst in the **ON/OFF** mode the TTL output is actuated when the corresponding **SETPOINT** relay changes its position. Press the **OK** key to confirm the choice.

When choosing the proportional mode, four parameters must be set to allow the TTL output to operate correctly, as follows:

- **PULSE WIDTH**
- **VAL @ MAX F**
- **MAX FREQUENCY**
- **MIN FREQUENCY**

7.5.5.1. PULSE WIDTH

This parameter represent the time during the which the TTL output is **ON**.

After set the **PULSE WIDTH** parameter, press **OK** key to set the value.

7.5.5.2. VAL@MAX F

This parameter represent the measure where the frequency of the TTL output is on **MAX** value.

After set the **VAL@MAX F** parameter, press **OK** key to set the value.

7.5.5.3. MAX FREQUENCY

This parameter represent the maximum frequency of the TTL output.

After set the **MAX FREQUENCY** parameter, press **OK** key to set the value.

7.5.5.4. MIN FREQUENCY

This parameter represent the minimum frequency of the TTL output.

After set the **MIN FREQUENCY** parameter, press **OK** key to set the value.

7.5.6. METER READING @4mA

This parameter represent the measure value where the output mA signal is equal to 4mA.

After set the **METER READING @4mA** parameter, press **OK** key to set the value on right column.

7.5.7. METER READING @20mA

This parameter represent the measure value where the output mA signal is equal to 20mA.

After set the **METER READING @20mA** parameter, press **OK** key to set the value on right column.

7.6. MENU CALIBRATION

Starting from the MAIN SCREEN press OK key than press + key to move the selector on MENU CALIBRATION.

Press OK key to enter.

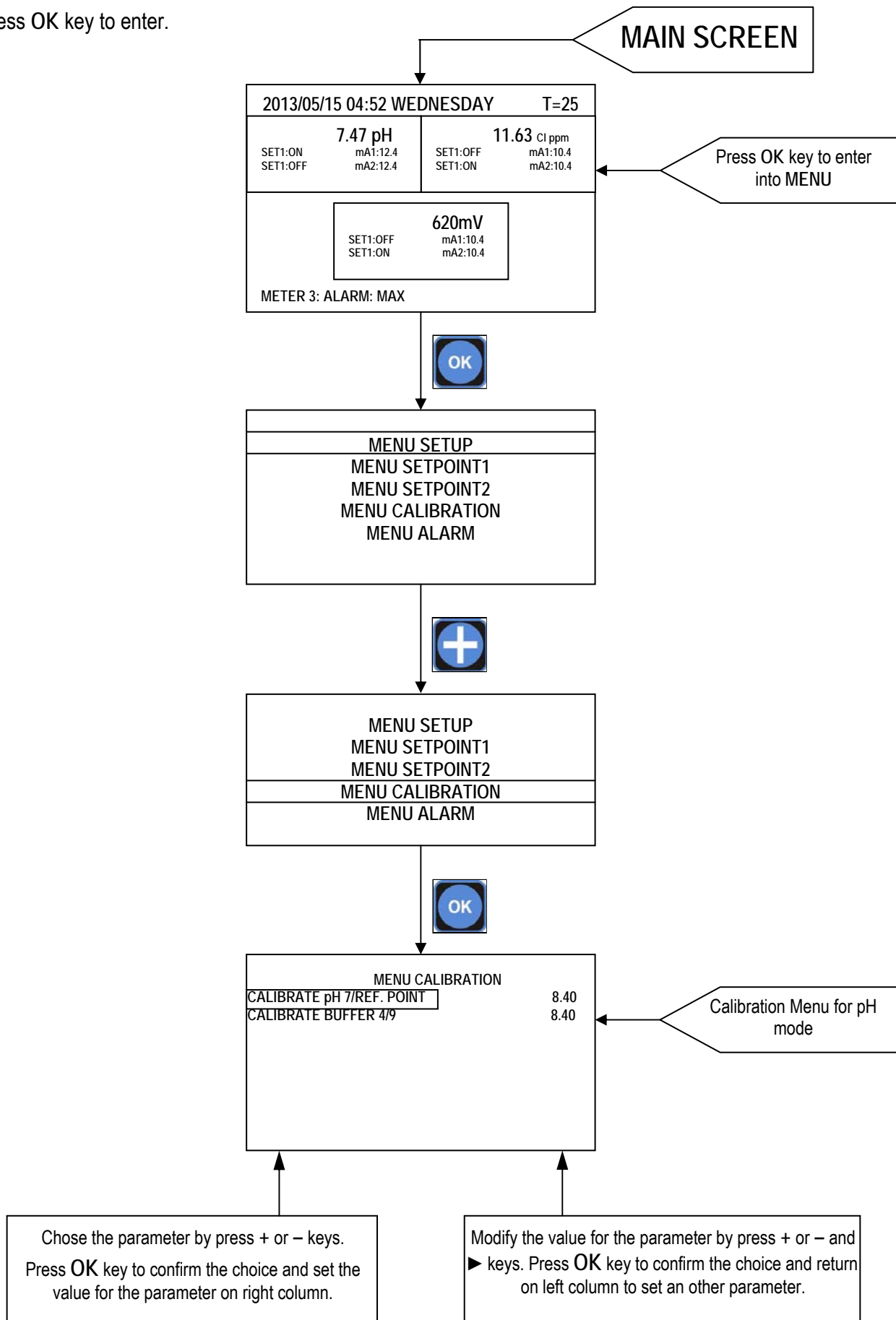

7.6.1. CALIBRATE pH 7/REF.POINT

The menu CALIBRATION allows the user to calibrate the instrument through the use of buffer solutions.

After press CALIBRATE pH 7/REF. POINT dipping the probe in the pH 7 buffer solution is the calibration procedure's first step. When the reading is stable, adjust the value by using the + and – keys and press ► key to confirm.

The next step is to put the probe into pH 4 or pH 9 buffer solution and press OK on CALIBRATE BUFFER 4/9. When the reading is stable, adjust the value by using the + and – keys and press ► key to confirm.

The instrument is so calibrated.

For Redox and Chlorine, calibrate first calibration point by using buffer solution (e.g. 650mV) or by using a photometer (CALIBRATE BUFFER for REDOX and CALIBRATE DPD1 for CLORINE).

Second calibration point (available in EXPERT mode only) is the "ZERO", which is possible to calibrate by disconnect the probe and shortcutting BNC input connector.

7.7. MENU ALARM

Starting from the MAIN SCREEN press OK key than press + key to move the selector on MENU ALARM.

Press OK key to enter.

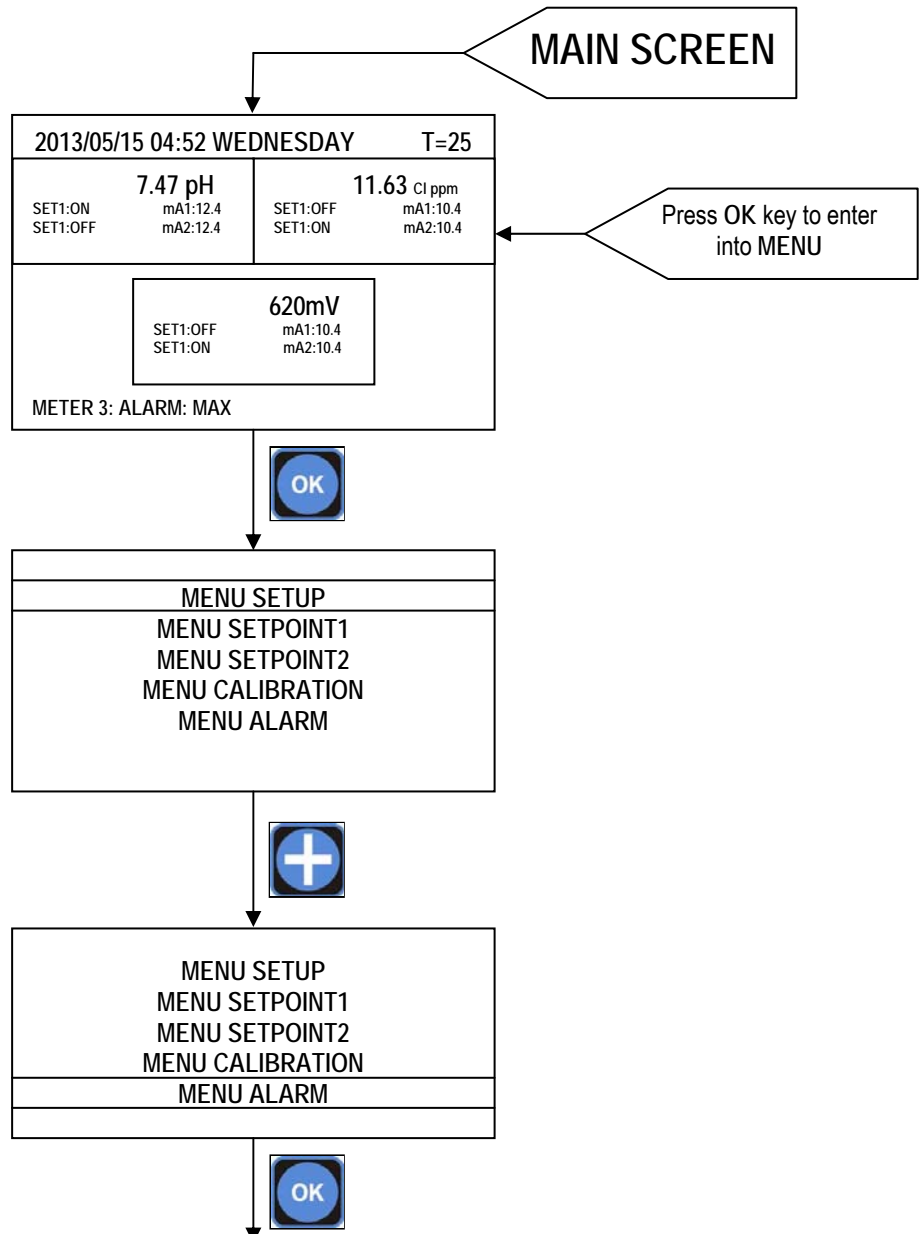

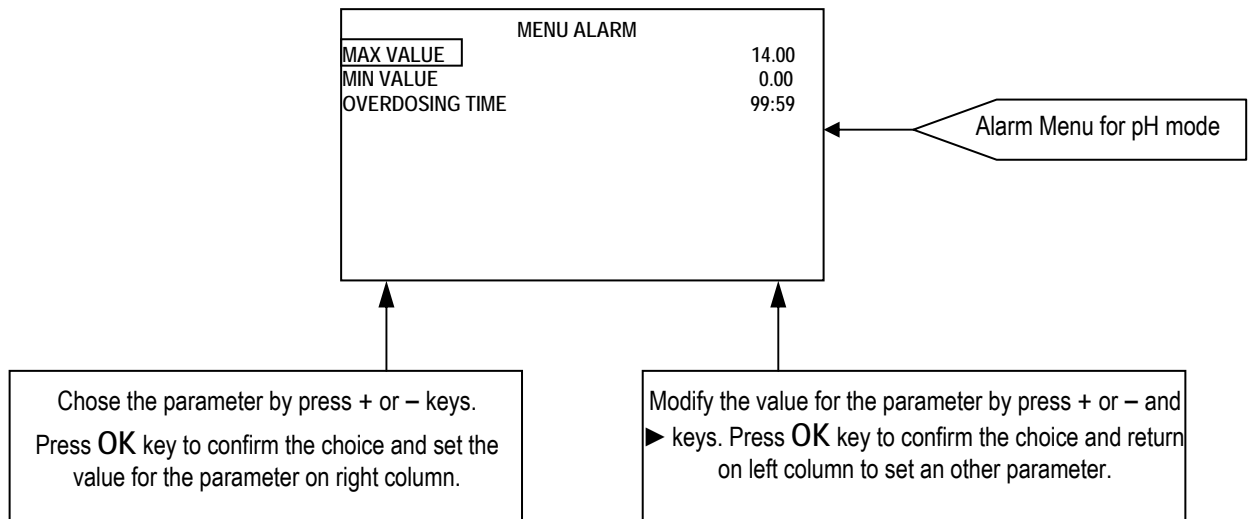

7.7.1. MENU ALARM SETTINGS

The instrument features various alarms that can be configured by the user; three types of alarm can be set:

MAX VALUE – The instrument raises an alarm above a given measurement value.

MIN VALUE – The instrument raises an alarm below a given measurement value.

OVERDOSING TIME – The instrument raises an alarm when a given time interval has elapsed and the measurement has not come back to the intended setpoint values.

8. INPUT/OUTPUT CONNECTIONS

8.1. PROXIMITY SENSORS

B2 and B3 controllers have one REMOTE input for each measure channel to which proximity sensor can be connected (see page #4 for ESELECT B2 and page #6 for ESELECT B3).

The proximity sensor when is inserted in the probe holder, signal the presence of water in the installation and therefore the need to start the inspection. In order to activate the controller, the proximity sensor should be Normally Closed.

When there is no water flow (the contact on REMOTE INPUT is open) than a **STAND-BY** alarm will shows on the display. It is possible to use one proximity sensor for all input measure by put a short-circuit connector on slave position as show on the following scheme. If the short circuit connector is put on **INDEPENDENT** position the two REMOTE INPUTS will work separately.

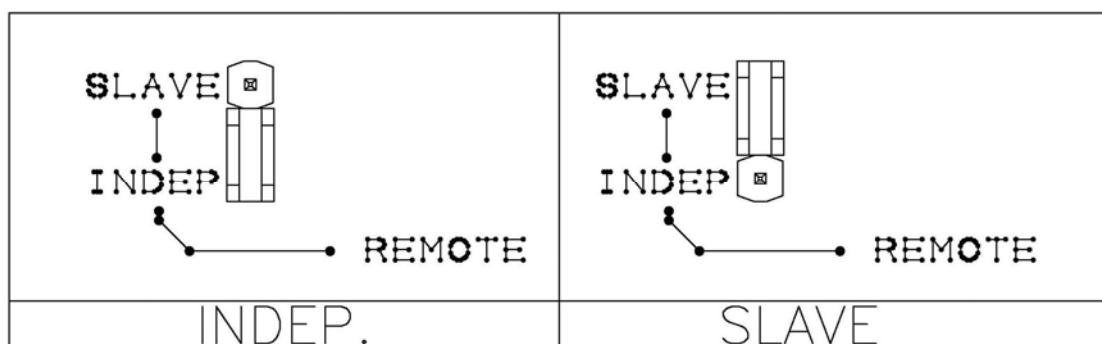

8.2. PT100 CONNECTION

As it is possible to see on the connection diagram represented in Fig. 1 the controller foresees the mounting of the PT100, 3 wire sensors.

Regarding the two poles PT100 it is necessary to short circuit the two terminals of the clamps marked "C" with a clevis (fig.1) and connect the two wires of the PT100 between one of the above poles "C" and the third pole which is still free; instead for the four wire one it is necessary to connect both wires to one of the two pairs of twisted wires at the third pole and the other two wires of the other twisted pair to the two poles marked "C".

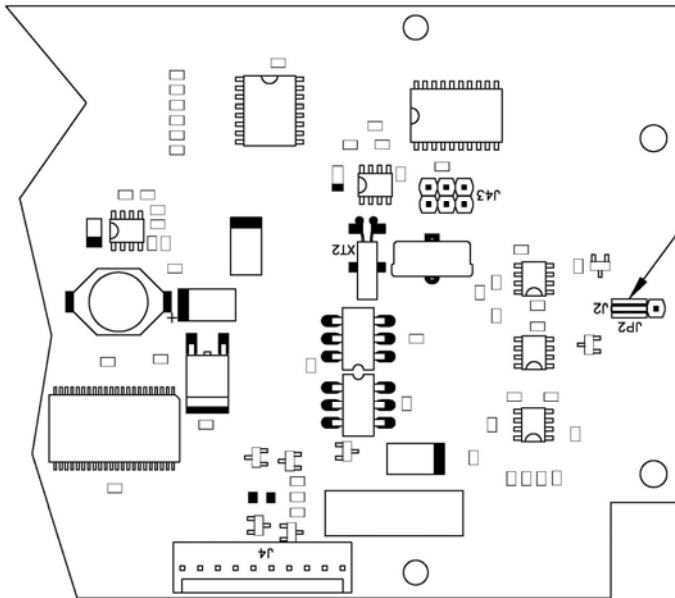

This jumper has to be positioned as indicated to select PT100 temperature sensor



ETATRON D.S.



HEAD OFFICE - ITALY

Via dei Ranuncoli, 53 - 00134 ROMA - ITALY

Phone +39 06 93 49 891 - Fax +39 06 93 43 924

e-mail: info@etatronds.com - web: www.etatronds.com

ITALY (BRANCH OFFICE)
ETATRON D.S.
Via Ghisalba, 13
20021 Ospiate di Bollate
(MI) ITALY
Phone +39 02 35 04 588
Fax +39 02 35 05 421

ASIA ETATRON D.S.
(Asia-Pacific) PTE Ltd
67 Ubi Crescent, #03-05
Techniques Centre
Singapore 408560
Republic of Singapore
Phone +65 67 43 79 59
Fax +65 67 43 03 97

USA - CANADA - MEXICO
ETATRON AMERICA
1642 McGaw Avenue
Irvine, CA 92614
USA
Phone +1 949 251 8700
Fax +1 949 752 7867

ESPAÑA - ETATRON
DOSIFICACION Y MEDICION S.L.
Avda. Letxumboro 83
Pabellón 6
Irún (20305) ESPAÑA
Phone +34 902 09 93 21
Fax +34 943 09 03 12
www.etatron.es

BRASIL
ETATRON do Brasil
Rua Vidal de Negreiros, 108
Bairro Canindé - CEP 03033-050
SÃO PAULO SP
BRASIL
Phone/Fax +55 11 3228 5774

RUSSIAN FEDERATION
DOSING SYSTEMS
3-rd Mytishenskaya, 16/2
129626 Moscow
RUSSIA
Phone +7 495 787 1459
Fax +7 495 787 1459

UKRAINE
000 ETATRON - UKRAINE
Soborna Street, 446
Rivne, 33024 Rivne Region
UKRAINE
Phone +380 36 26 10 681
Fax +380 36 26 22 033

UNITED KINGDOM
Etatron GB
Lindum Business Park
Station Road North Hykeham
Lincoln, LN6 3QX UK
Phone +44 (0) 1522 85 23 97
Fax +44 (0) 1522 50 03 77

ETATRON FRANCE
1 Mail Gay Lussac
95000 Neuville Sur Oise
Tel: +33 (0)1 34 48 77 15
Fax: +33 (0)1 78 76 73 95

COD. DMU00193ML1-B (02-2015)